

# Oil circulation lubrication systems

Product catalogue



## Table of contents

<b>Two leading brands</b> . . . . .	<b>4</b>	<b>Overview of oil circulation metering devices</b> . . . . .	<b>45</b>
<b>Lubricants suitable for lubrication systems</b> . . . . .	<b>5</b>	VD . . . . .	48
<b>System description</b> . . . . .	<b>6</b>	SMT . . . . .	50
<b>System advantages</b> . . . . .	<b>7</b>	242 . . . . .	52
<b>Applications</b> . . . . .	<b>7</b>	SKF VarioLub . . . . .	54
<b>Recommended product combinations</b> . . . . .	<b>8</b>	SKF Safeflow . . . . .	56
<b>System component highlights</b> . . . . .	<b>9</b>	SKF Flowline Monitor . . . . .	58
 		SMB 3 . . . . .	60
<b>Overview of oil circulation supply units</b> . . . . .	<b>11</b>	SMB 6 . . . . .	62
MF . . . . .	12	SMB 8 . . . . .	64
FLMF . . . . .	14	SMB 9 . . . . .	68
SM-100 . . . . .	16	SMB 10 . . . . .	72
OCU . . . . .	18	SMB 13 . . . . .	76
Flowline . . . . .	20	SMB 14 . . . . .	78
Streamline . . . . .	22	PSG1 . . . . .	80
 		PSG2 . . . . .	82
<b>Overview of oil circulation pumps</b> . . . . .	<b>25</b>	PSG3 . . . . .	84
M/MF . . . . .	26	VP . . . . .	86
FLM/FLMF . . . . .	28	 	
ZP . . . . .	30	<b>Overview of oil circulation control units and software</b> . . . . .	<b>89</b>
ZM (single-circuit) . . . . .	32	ST-2240 CIRC . . . . .	90
143 without motor . . . . .	34	PGA 3 . . . . .	91
143 with motor . . . . .	36	SKF Flowline Software . . . . .	92
143 EEX . . . . .	38	SKF VarioLub Software . . . . .	93
ZM (multi-circuit) . . . . .	40	 	
ZPU 09/09A . . . . .	42	<b>Overview of oil circulation monitoring devices</b> . . . . .	<b>95</b>
		WS 32/33/35 . . . . .	96
		WS63-2 . . . . .	98
		WS68 . . . . .	99
		171-210 . . . . .	100
		IPM 12 . . . . .	102
		SFZ . . . . .	104
		<b>Overview of oil circulation system accessories</b> . . . . .	<b>107</b>
		169-460-... . . . . .	108
		<b>Index</b> . . . . .	<b>110</b>

## Navigation

Introduction . . . . .	4
Oil supply units . . . . .	11
Pumps . . . . .	25
Metering devices . . . . .	45
Control units . . . . .	89
Monitoring devices . . . . .	95
Accessories . . . . .	107

## Two leading brands



### One global leader

SKF and Lincoln have joined forces to provide you with the world's most complete portfolio of innovative lubrication solutions – from manual lubricators and tools, to the most advanced centralized and automatic lubrication systems available.

In addition to traditional lubrication products and systems, we offer customized solutions for many industries such as pulp and paper, steel, mining, agriculture, marine, rail, wind, construction, machine tool and automotive. SKF engineering and technical specialists partner with OEMs and end-users to develop system solutions based on customer requirements. We also offer a variety of control and monitoring equipment for ease of use and to help ensure proper lubrication.

Both SKF and Lincoln systems are available through our global network of lubrication experts, offering you world-class installation and ongoing support on a local level – today and into the future. With the power of this network, and more than 200 years of combined friction management experience, we can help you improve machine reliability, reduce maintenance, increase productivity, enhance safety and optimise manpower resources.

# Lubricants suitable for lubrication systems

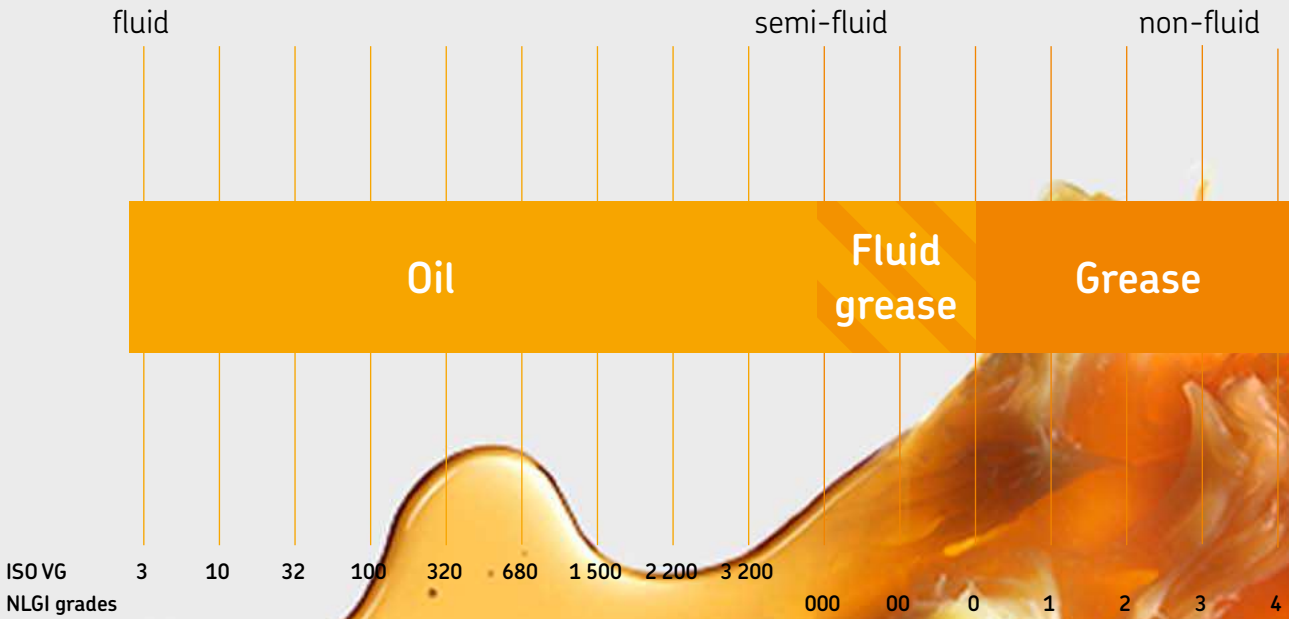

## Oil and fluid grease

The viscosity is an expression of a fluid's internal friction. Oils are classified in ISO VG viscosity classes from 2 to 3 200. NLGI grade 000, 00 and 0 greases are called fluid greases. Different types of oils are available, including mineral oils, organic oils and synthetic oils. A compatibility check is recommended prior to using any oil with SKF lubrication systems.



## Grease

Greases are consistent lubricants (NLGI grade 1–6). They are soft to hard, triple-component mixtures of a base oil as the lubricating fluid, a thickening agent and additives. In most instances, greases of NLGI grade 1 up to 3 are suitable for use in a lubrication system. A compatibility check should be made prior to using any grease with SKF lubrication systems.

## Oil circulation lubrication systems

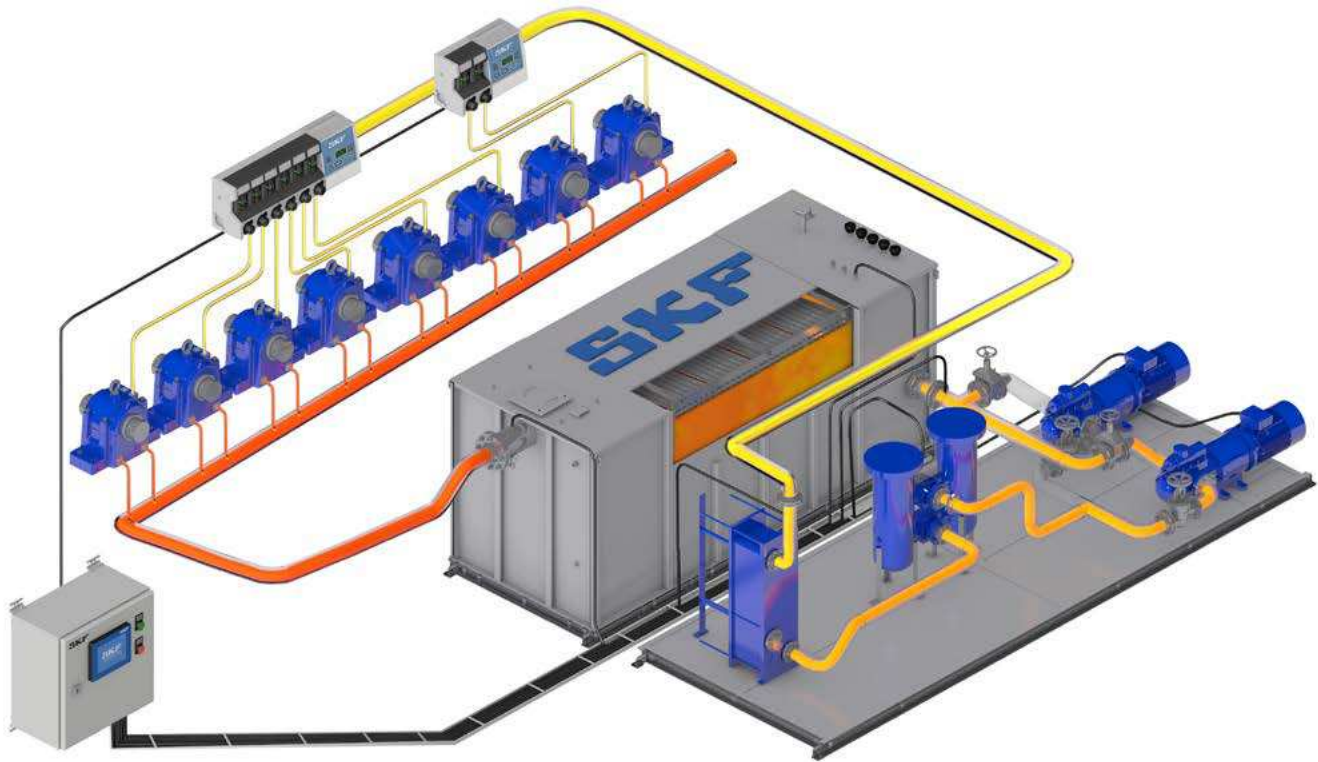

### System description

SKF CircOil systems are designed primarily for oil circulation lubrication to lubricate as well as cool highly stressed bearings in nearly every size of machine. Additionally, the returning oil removes and filters out wear particles from friction points and prevents corrosion damage by removing air and water from bearings. Thus, a continuous oil flow is necessary. SKF CircOil systems include a wide range of customized and turnkey solutions for flow rates from 0,1–3 000 l/min. They are simple to service and feature a modular design that can be expanded easily. Our patented tank design with the SKF plate separator technology increases operating efficiency to up to 90%. An oil supply system delivers the lubricant to the adjustment valves with individual settings. Flow rates can be controlled visually or electronically. Monitoring systems with a flow rate read-out function and individual warning levels are available for a more predictive maintenance approach.

Oil circulation lubrication systems are used in pulp and paper and printing industry, as well as in many other industries. They also are used in heavy industries like marine or tunnel boring. In addition, SKF offers a range of oil circulation EEX components and systems specially designed for operations in harsh conditions and explosive atmospheres like mining or cement mills.

SKF oil circulation system consist of the following components:

- An oil supply unit with oil reservoir and pump unit/station (optionally equipped with filters and oil conditioning units)
- A control device
- One or several monitoring devices
- One or several flow metering devices
- One or several sump units
- Fittings and pipes

When planning a lubrication system, ambient conditions must be determined first. The number of lubrication points, back pressures at the lubrication points, operating temperature range, the feed pump's drive energy, control and monitoring etc. must be defined correctly. Attention also must be given to bearing or lubrication point information. The sum of all the quantities metered out by the system's metering devices needs to be completed by safety margin and expansion and compressibility loss. SKF application engineers as well as SKF sales partners and distributors, are experts in designing lubrication systems according to these specifications. A lubrication system laid out by SKF and partners ensures the supply of the correct amount of lubricant at the best time to lubricate. This reduces wear and minimizes pollution caused by over-lubrication.



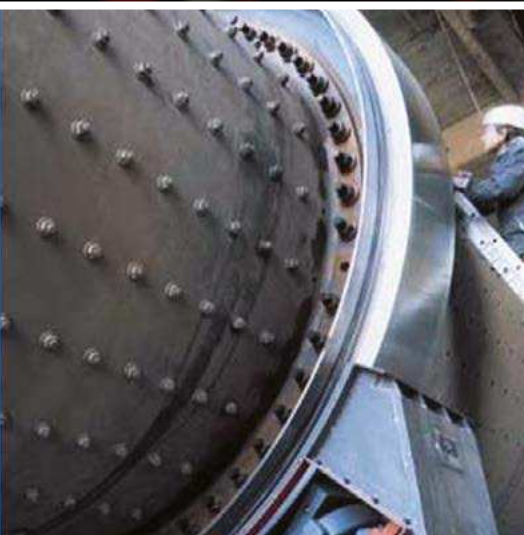
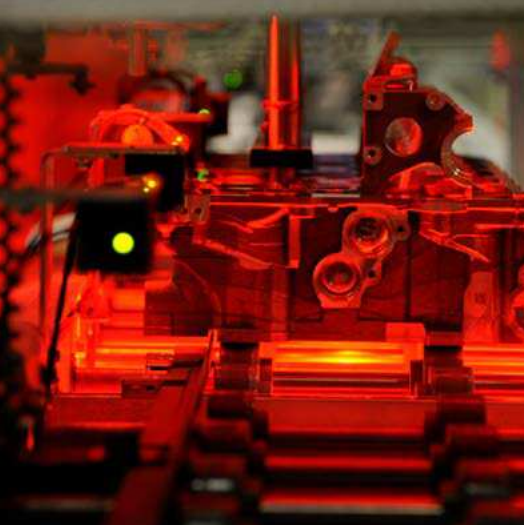

## System advantages

- Cools highly stressed bearings
- Removes particles from bearings
- Durable pump series designed for 24/7 operation
- Oil reservoir sizes from 3 to 40 000 liters; (0.79 to 10 567 gal)
- High operating efficiency
- Easy expansion of the lubrication system
- Able to pump long distances and within a wide temperature range

## Applications

SKF CircOil lubrication systems are suitable for various industries that operate 24/7. While cooling is the predominant task of these systems, they equally supply bearings and gearboxes with clean oil at the correct temperature and viscosity. Small, highly efficient oil reservoirs provide a high level of machine availability and save money at the same time.

A large variety of flow meters allows for fit-for-purpose solutions and offers state-of-the-art monitoring and digitalization of flow information. Tailor-made controllers support stand-alone operation of SKF oil circulation lubrication systems.

- Pulp and paper industry
- Metals
- Automobile presses
- Automation
- Printing
- Food and Beverage
- ATEX
- API

## Recommended product combinations

### Product combination matrix

	Oil supply units					Pumps									
	MF	FLMF	SM-100	OCU	Flowline	Streamline	M/MF	FLM/ FLMF	ZP	ZM <sup>1)</sup>	ZM <sup>2)</sup>	143 <sup>3)</sup>	143 <sup>4)</sup>	143 EEX	ZPU 09/ ZPU 09A
Metering devices															
VD	•	•	–	–	–	–	•	•	•	•	–	–	–	–	–
SMT	–	–	–	–	–	•	–	•	•	•	–	•	•	•	–
242	•	•	–	–	–	–	•	•	•	•	–	–	–	–	–
Variolub	–	–	–	–	–	•	–	–	–	–	–	•	•	–	–
Safeflow	–	–	•	–	•	–	–	–	–	–	–	•	•	–	–
Flowline monitor	–	–	•	–	•	–	–	–	–	–	–	•	•	–	–
SMB 3	–	–	–	–	–	•	–	–	–	–	–	•	•	•	–
SMB 6	–	–	–	–	–	•	–	–	–	–	–	•	•	•	–
SMB 8	–	–	–	–	–	•	–	–	–	–	–	•	•	•	–
SMB 9	–	–	–	–	–	•	–	–	–	–	–	•	•	•	–
SMB 10	–	–	–	–	–	•	–	–	–	–	–	•	•	•	–
SMB 13	–	–	–	–	–	•	–	–	–	–	–	•	•	•	–
SMB 14	–	–	–	–	–	•	–	–	–	–	–	•	•	•	–
PSG 1	–	–	–	–	–	•	–	–	–	–	–	•	•	•	–
PSG 2	–	–	–	–	–	•	–	–	–	–	–	•	•	•	–
PSG 3	–	–	–	–	–	•	–	–	–	–	–	•	•	•	–
VP	–	–	–	–	–	–	–	–	–	–	–	•	•	•	–
Control units															
ST-2240-Circ	–	–	•	–	•	•	–	–	–	–	–	–	–	–	–
PGA 3	–	–	–	–	–	•	–	–	–	–	–	–	–	–	–
Flowline Software	–	–	–	–	•	–	–	–	–	–	–	–	–	–	–
Variolub Software	–	–	–	–	–	•	–	–	–	–	–	–	–	–	–
Monitoring devices															
WS 32/33/35	•	–	–	–	–	–	–	–	–	–	–	–	–	–	–
WS63-2/68	•	–	–	–	–	–	–	–	–	–	–	–	–	–	–
171-210	•	–	–	–	–	–	•	•	•	•	–	–	–	–	–
IPM 12	–	–	–	–	–	•	–	–	–	–	–	–	–	–	–
SFZ	•	•	–	•	•	•	•	•	•	–	•	•	•	•	–
Accessories															
169-460-...	•	•	–	–	–	–	•	•	•	•	•	•	•	•	•

1) ZM (single-circuit)

2) ZM (multi-circuit)

3) 143 without motor

4) 143 with motor

### Examples for oil circulation system configurations

System	Oil supply unit	Metering device	Monitoring device	Control unit
Flow limiter system	Streamline	SMB flow limiter, PSG metering device, SMT flow divider	IPM-12	ST-2240-Circ
Variolub system	Streamline, Flowline	SMD Variolub	IPM-12	ST-2240-Circ
Safeflow system	Flowline, Streamline, SM-100	SF Safeflow	included	ST-2240-Circ
Flowline monitor system	Flowline, Streamline, SM-100	FL Flowline monitor	included	ST-2240-Circ
242 series system	SM-100	242 restrictor	–	ST-2240-Circ



## System component highlights



### Streamline

SKF's customized solution when it comes to oil circulation lubrication systems. They come with reservoir sizes of up to 40 000 liters in both carbon steel and stainless steel. → Page 22



### Flowline

They provide superior water and air separation properties. Their cylindrical stainless steel reservoirs typically require only one-third of the tank volumes of traditional oil tanks. → Page 20



### SM-100

SM-100 is a compact, small oil circulation system. The unit can provide oil for one or two small machines with a total flow rate of 7 l/min. → Page 16



### SMB flow limiter

They divide main line flow into parallel, individual flows. The flow is generated independently of system pressure changes virtually guaranteeing a constant flow. → Page 68



### SMD flow meter

They meter and monitor the flow in oil circulation lubrication systems. They are offered in three different versions covering a flow rate of 0,05 to 40 l/min. → Page 54



### Safeflow flow meter

They control and indicate the flow rate in oil circulation lubrication systems. Each flow meter can be calibrated individually and cover a flow rate of 0,04 to 56 l/min. → Page 56



### FL flowline monitor

They divide, measure and control the flow rate in a systems. Monitors 0,1 to 100 l/min flows with operating viscosities from 32 to 1 000 mm<sup>2</sup>/s. → Page 58



### PSG metering valve

Progressive metering devices consisting of a baseplate and different metering sections that can be individually combined for specific outlet ratios and cross portings. → Page 80



### ST-2240-Circ controller

A stand-alone controller for oil circulation lubrication systems. It comes with a touch screen and remote smart phone options. → Page 90

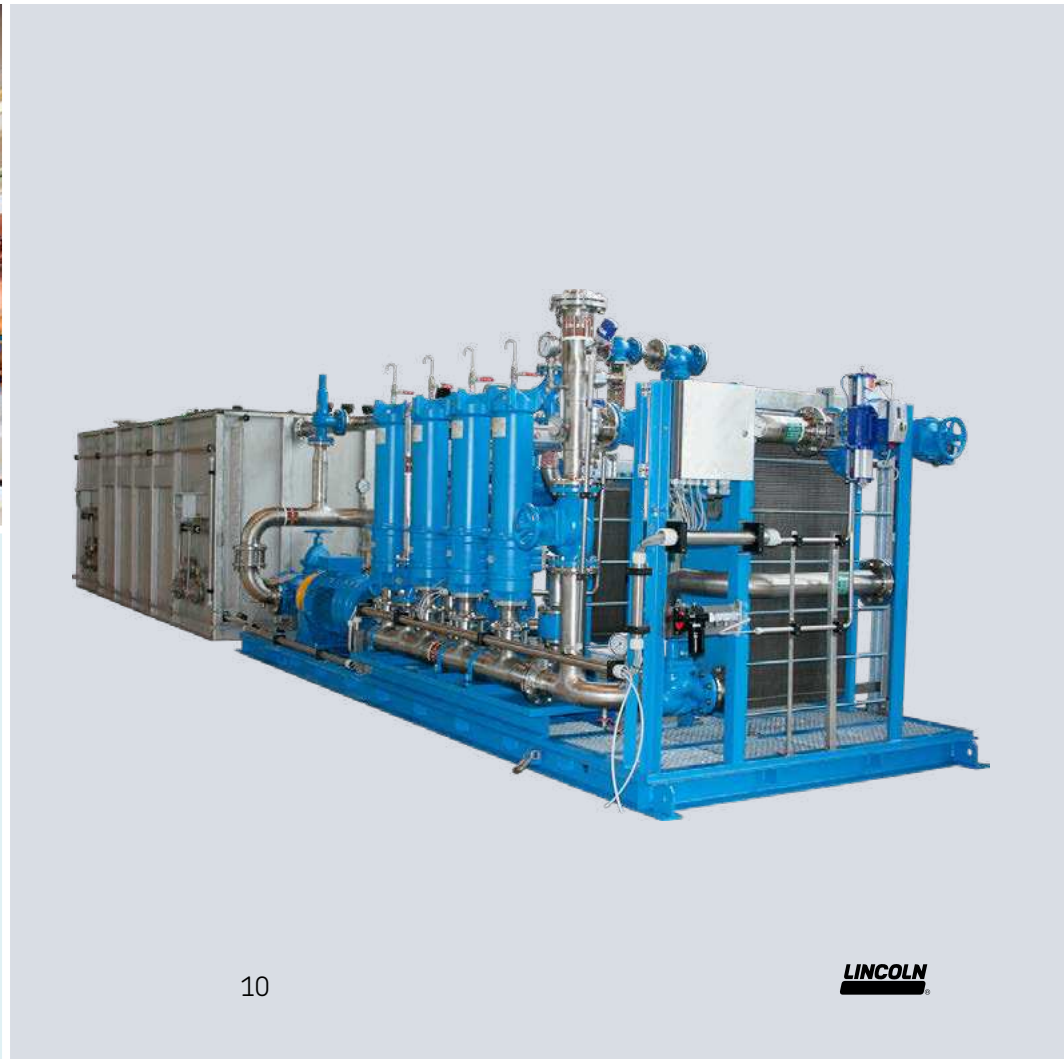

## Overview of oil circulation supply units

Oil supply units									
Product	Lubricant mineral and synthetic oil	Flow rate <sup>1)</sup>		Ambient temperature		Reservoir size		Reservoir material	Page
		viscosity ISO VG	l/min	pts/min	°C	°F	l		
<b>MF</b>	5–2 000	0,12–0,5	0.23–1.06	10 to 40	50 to 104	2,7–50	5.7–105	plastic/metal	12
<b>FLMF</b>	20–850	1,2–2,4	2.5–5.0	10 to 40	50 to 104	2,7–50	5.7–105	metal	14
<b>SM-100</b>	30–1 000	2–7	4.2–14.8	0 to +70	+32 to 158	100	211	steel	16
<b>OCU</b>	15–800	5–30	10.5–63.4	-10 to 40	14 to 104	–	–	–	18
	viscosity ISO VG	l/min	gal/min	°C	°F	l	gal		
<b>Flowline</b>	20–1 000	30–1 200	8–317	10 to 40	50 to 104	300–2 × 6 000	80–2 × 1 585	stainless steel AISI 304, 316	20
<b>Streamline</b>	20–1 000	30–4 000	8–1 056	10 to 40	50 to 104	1 000–40 000	264–10 566	carbon steel or stainless steel AISI 304, 316	22

<sup>1)</sup> Valid for operating viscosity of 140 mm<sup>2</sup>/s

## Gear pump unit

# MF



### Description

MF single-circuit gear pump units are used in small oil circulation lubrication systems with pressure ranges up to 65 bar (940 psi) and high viscosities up to 2 000 mm<sup>2</sup>/s. The pump is vertically mounted on the reservoir.

MF gear pumps come with integrated pressure relief and venting valves that feed into the internal return oil connection in the adapter flange. In case of trapped air, the venting valve opens. In case of excess pressure, oil is relieved to the return oil connection via the pressure relief valve.

### Features and benefits

- Designed for 24/7 operation
- Inexpensive solution
- High viscosity range
- Compact, rugged and reliable design
- Low noise level
- Integrated pressure relief valve and venting valve

### Applications

- Machine tools
- Automotive
- Automation
- Textile machinery
- Metal and plastic forming machinery
- Printing

### Technical data

Function	electrically operated gear pump unit; single circuit
Lubricant	environmentally friendly mineral and synthetic oils; viscosity 5–2 000 mm <sup>2</sup> /s
Flow rate	0,12–0,5 l/min; 0,25–1,06 pts/min
Number of outlets	1
Ambient temperature	+10 to 40 °C; +50 to 104 °F
Oil temperature	+10 to 65 °C; +50 to 149 °F
Operating back pressure	max. 65 bar; max. 940 psi
Suction height	500 mm; 19,68 in
Drive speed	2 600–2 700 min <sup>-1</sup>
Motor <sup>1)</sup>	3-phase motor
Voltage	220–240/380–420 V AC at 50 Hz
Rated power	0,075–0,18 kW
Pressure connection	M 14 × 1,5 for Ø 8 mm
Seal material	NBR, FPM
Reservoir	2,7l; 6l; 15 l; 50l; 5,7pts; 12,7 pts; 31,7 pts; 105 pts
Reservoir material	plastic, metal
Protection class	IP 54
Dimensions	min. 131 × 88 × 209 mm max. 131 × 88 × 220 mm min. 5,16 × 3,54 × 8,23 in max. 5,16 × 3,54 × 8,66 in
Mounting position	horizontal <sup>2)</sup> or vertical
Approvals (dep. on model)	CE, UL, CSA

<sup>1)</sup> Further motor designs available on request.

<sup>2)</sup> with special seal design



### NOTE

Further technical information, technical drawings, accessories, spare parts or product function descriptions available on [SKF.com/lubrication](http://SKF.com/lubrication):

**1-1204-2-EN, 951-170-001 EN, 951-170-002 EN**

## Gear pump unit

# MF

### MF pump unit with reservoir

Order number <sup>1)</sup>	Viscosity	Flow rate <sup>2)</sup>		Reservoir size		material	design	level sensor	filter	gauge
		mm <sup>2</sup> /s	l/min	pts/min	l					
<b>MF1-BW3-S20+1FV</b>	20–2 000	0,12	0.25	2,7	5,7	metal	wall mounting	min. fill level warning	–	–
<b>MF1-KW3-S15+1FX</b>	20–1 000	0,12	0.25	2,7	5,7	plastic	wall mounting	min. fill level warning	–	yes
<b>MF2-BW7+299</b>	20–1 000	0,20	0.42	6	12.7	metal	wall mounting	min. fill level warning	–	–
<b>MF2-KW6-S8+299</b>	20–2 000	0,20	0.42	6	12.7	plastic	wall mounting	–	pressure filter	–
<b>MF5-BW7+140</b>	20–1 000	0,50	1.0	6	12.7	metal	wall mounting	min. fill level warning	–	–
<b>MF5-KW6+299</b>	20–1 000	0,50	1.0	6	12.7	plastic	foot design	min. fill level warning	–	–
<b>MF5-BW16-S223+299</b>	20–1 000	0,50	1.0	15	31.7	metal	foot design	min. and max. fill level warning	–	–
<b>MF5-BW51-S22+29G</b>	20–1 000	0,50	1.0	50	105	metal	foot design	min. and max. fill level warning	pressure filter	yes

<sup>1)</sup> Recommended oil filtration for MF pumps: According to ISO 440620/17/14, NAS code (1638) class 8, SAW AS 4059 class 8

<sup>2)</sup> On an operating viscosity of 140 mm<sup>2</sup>/s and 5 bar back pressure



## Vane pump unit

# FLMF

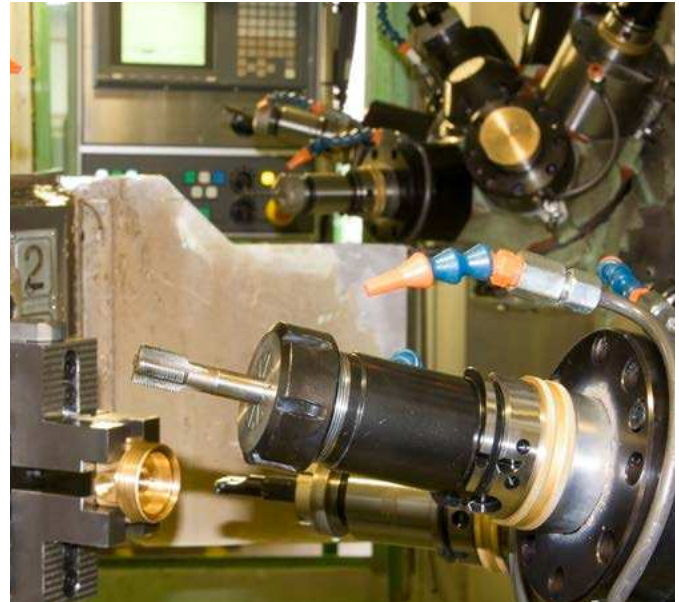

### Description

The SKF FLM vane pump unit is a simple and reliable solution suitable for usage in small oil circulation systems with low pressure and low viscosity range. Because of its high suction capacity of up to 3 m (the SKF FLM pump unit is often used as a sump pump). SKF vane pumps can deliver both oil and oil/air mixtures and provide a higher suction capability than gear pump units. Two different pump designs of the pump unit are available: one allows the pump to be mounted separately from the reservoir (FLM) and the other allows the pump to be flange-mounted on the reservoir (FLMF) both vertically and horizontally. When installed on the side (horizontally), ensure that the unit is mounted above the maximum lubricant level. Special designs with a sealed flange for mounting below the lubricant level are available on request.

### Features and benefits

- Simple, reliable and cost-effective solution
- Low-wear and low-maintenance
- High suction capacity (3 m)
- Designed for 24/7 operation
- Delivers oil and air mixtures
- Fail safe running functions

### Applications

- General Industry
- Machine Tools
- Automotive
- Automation

### Technical data

Function	electrically operated vane pump unit
Lubricant	oil, viscosity 20–850 mm <sup>2</sup> /s
Flow rate	1,2–2,4 l/min; 2,5–5,0 pts/min
Number of outlets	1
Ambient temperature	+10 to 40 °C; +50 to 104 °F
Oil temperature	+10 to 65 °C; +50 to 149 °F
Operating back pressure	max. 6 bar, max. 87 psi
Suction height <sup>1)</sup>	max. 3 000 mm; 118.1 in
Drive speed	2 700 min <sup>-1</sup>
Motor <sup>2)</sup>	3-phase motor
Voltage	220–240/380–420 V AC at 50 Hz
Rated power	0,075 kW
Suction connection	M16×1,5
Pressure connection	M14×1,5
Reservoir	2,7–50 l; 5,7–105 pts
Reservoir material	plastic, metal
Protection class	IP 54
Dimensions	max. 216 × 88 × 134,5 mm max. 8,5 × 3,46 × 5,29 in
Mounting position	horizontal

<sup>1)</sup> Based on operating viscosity of 140 mm<sup>2</sup>/s at a back pressure of p = 5 bar.

<sup>2)</sup> Further motor designs available on request.



### NOTE

Further technical information, technical drawings, accessories, spare parts or product function descriptions available on [SKF.com/lubrication](http://SKF.com/lubrication):

**1-1204-2-EN, 951-170-001 –EN, 951-170-002 –EN**



3D

[skf-lubrication.partcommunity.com/3d-cad-models](http://skf-lubrication.partcommunity.com/3d-cad-models)

## Vane pump unit

# FLMF

### FLMF with reservoir

Order number <sup>1)</sup>	Viscosity		Flow rate <sup>2)</sup>		Back pressure		Reservoir size		Suction height		design	level sensor
	mm <sup>2</sup> /s	l/min	pts/min	bar	psi	l	pts	mm	in			
<b>FLMF12-BW3-2+299</b>	20–850	1,2	2.5	6	87	2,7	5.7	3 000	118	wall mounting	min. and fill level	
<b>FLMF12-BW7+299</b>	20–850	1,2	2.5	6	87	6	12.6	3 000	118	wall mounting	min. and fill level	
<b>FLMF12-BW16+299</b>	20–850	1,2	2.5	6	87	15	31.7	3 000	118	foot design	min. and fill level	
<b>FLMF24-BW51-S2+MWZ</b>	20–500	2,4	5.0	3	44	50	105	1 000	40	foot design	min. and max. fill level	

<sup>1)</sup> Recommended oil filtration for MF pumps: According to ISO 440620/17/14, NAS code (1638) class 8, SAW AS 4059 class 8

<sup>2)</sup> On an operating viscosity of 140 mm<sup>2</sup>/s and 5 bar back pressure

## Gerotor pump unit

## SM-100



## Description

SM-100 is a complete small oil circulation system. The unit can provide oil for one or two small machines with a total flow rate of 7 l/min. The system pressure level is adjusted by variable speed drives (VFD). Other typical systems utilize an overflow valve leading to energy losses, component wear and oil degradation. The reservoir is equipped with a heater to control oil viscosity at start up. An optional cooler is furnished to reduce the filtered oil temperature supplied to the bearings. The filter cartridge can be changed during operation, using a by-pass valve. For even larger fans, SKF has Flowline, a full oil circulation system family with necessary customized designs to fulfill customer requirements.

## Features and benefits

- Energy saving compact oil supply unit for one or two pumps
- Easy to use, to locate and to install
- Efficient air cooler, special application without cooler
- Compact power supply unit with frequency converters (VFD), available also without power supply
- Compact electronic control system, available also without control

## Applications

- Fans, gears, refiners, washers, gear boxes, motors
- Presses, rolls, pumps, chippers
- Etc.

## Technical data

Function	electrically operated gerotor pump unit
Lubricant	lubrication and hydraulic oils; 30 to 1 000 mm <sup>2</sup> /s
Flow rate	2 to 7 l/min (6.8 l/min at 950 min <sup>-1</sup> ); 4,2 to 14.8 pts/min
Number of outlets <sup>1)</sup>	1–10
Ambient temperature	+10 to 40 °C; +50 to 104 °F
Oil temperature	+10 to 70 °C; +50 to 158 °F
Operating pressure	max. 10 bar; max. 145 psi
Reservoir	100 l; 211 pts
Reservoir material	carbon steel (painted)
Thermostat controlled heater for oil tank	20 to 50 °C in 6 h; 68 to 122 °F in 6 h
Oil filtering rate	5 micron
Voltage	400 VAC/50 Hz
Pressure connection	G / NPT 1/2; G / NPT 1; G / NPT 1 1/4
Protection class	IP 54
Dimensions	1 200 × 550 × 840 mm; 47.25 × 21.65 × 33 in
Mounting position	vertical

<sup>1)</sup> Number of outlets is depending on the design of the selected SKF Flowline Monitor.

## NOTE

Further technical information, technical drawings, accessories, spare parts or product function descriptions available on [SKF.com/lubrication](http://SKF.com/lubrication):

**6633EN**

## Gerotor pump unit

# SM-100

### Supply units

Order number	Designation	Number of pumps	Number of filters	Reservoir material	Cooler type	Control unit
<b>13141098</b>	SM-30-1P-1F-PNTST-XX	1	1	Painted	No	Relay control with power supply
<b>13141099</b>	SM-30-1P-1F-PNTST-WAC	1	1	Painted	Water	Relay control with power supply
<b>13141100</b>	SM-30-1P-1F-PNTST-AIC	1	1	Painted	Air	Relay control with power supply
<b>13143400</b>	SM-100-1P-1F-PNTST-XX	1	1	Painted	No	ST-2240
<b>13143410</b>	SM-100-2P-1F-PNTST-XX	2	1	Painted	No	ST-2240
<b>13143450</b>	SM-100-1P-1F-PNTST-WAC	1	1	Painted	Water	ST-2240
<b>13143420</b>	SM-100-1P-1F-PNTST-AIC	1	1	Painted	Air	ST-2240
<b>13143460</b>	SM-100-2P-1F-PNTST-WAC	2	1	Painted	Water	ST-2240
<b>13143430</b>	SM-100-2P-1F-PNTST-AIC	2	1	AISI 304	Air	ST-2240
<b>13143461</b>	SM-100-1P-2F-SS-XX	1	2 (Duplex)	AISI 304	No	ST-2240
<b>13143462</b>	SM-100-2P-2F-SS-XX	2	2 (Duplex)	AISI 304	No	ST-2240
<b>13143463</b>	SM-100-1P-2F-SS-WAC	1	2 (Duplex)	AISI 304	Water	ST-2240
<b>13143464</b>	SM-100-1P-2F-SS-AIC	1	2 (Duplex)	AISI 304	Air	ST-2240
<b>13143465</b>	SM-100-2P-2F-SS-WAC	2	2 (Duplex)	AISI 304	Water	ST-2240
<b>13143466</b>	SM-100-2P-2F-SS-AIC	2	2 (Duplex)	AISI 304	Air	ST-2240
<b>13143470</b>	SM-200-1P-2F-SS-xx	1	2 (Duplex)	AISI 304	No	ST-2240
<b>13143471</b>	SM-200-2P-2F-SS-xx	2	2 (Duplex)	AISI 304	No	ST-2240
<b>13143472</b>	SM-200-1P-2F-SS-WAC	1	2 (Duplex)	AISI 304	Water	ST-2240
<b>13143473</b>	SM-200-1P-2F-SS-AIC	1	2 (Duplex)	AISI 304	Air	ST-2240
<b>13143474</b>	SM-200-2P-2F-SS-WAC	2	2 (Duplex)	AISI 304	Water	ST-2240
<b>13143475</b>	SM-200-2P-2F-SS-AIC	2	2 (Duplex)	AISI 304	Air	ST-2240

## Gear pump unit

# OCU



### Description

OCU (Oil Conditioning Unit) is an electrically operated oil pumping, cooling and filtration system. It removes contamination and allows to condition oil temperature and contributes greatly to optimum lubrication with correct oil viscosity. There are three different OCU models available: without cooler, with air cooler or with water cooler. All models work in a side stream (kidney loop) configuration. The units are installed directly on the machine. Access ports should be located on opposing sides of the oil sump, so that suitable oil circulation is possible. Once installed the system is ready for continuous operation.

### Features and benefits

- Continuous lubricant cooling and filtration to extend machine life
- Eliminates wear and premature failures efficiently
- Optional available with frequency converter, electrical clogging indicator, temperature transmitter, pressure transmitter, gauge, shut-off valve, flowmeter, moisture transmitter or thermostat
- Dust proof cabinet with cooling or heating design on request
- Virtually maintenance free
- Easy to use and install

### Applications

- Large bearing houses
- Compressors
- Turbine systems
- Vacuum pumps
- Gearboxes

### Technical data

Function	electrically operated gear pump unit
Lubricant	lubrication and hydraulic oils; 15 to 800 mm <sup>2</sup> /s
Flow rate	5 to 30 l/min, 10.5 to 63 pts/min
Number of outlets	1-2
Ambient temperature	-10 to +40 °C; 14 to 104 °F
Oil temperature	-10 to +80 °C; 14 to 176 °F
Operating pressure	10 bar; 145 psi
Lubricant viscosity at start-up	2 000 mm <sup>2</sup> /s
Oil filtering rate	20 micron
Voltage	400/690 VAC/50 Hz 460 VAC/60 Hz
Inlet connection	G3/4
SKF-OCU-5	G1 1/2
SKF-OCU-10, 30	G1
Pressure connection	IP55
Protection class	min. 570 × 345 × 378 mm max. 570 × 800 × 920 mm
Dimensions	min. 22.4 × 13.6 × 14.9 in max. 22.4 × 31.5 × 36.2 in
Mounting position	horizontal

### NOTE

Further technical information, technical drawings, accessories, spare parts or product function descriptions available on [SKF.com/lubrication](http://SKF.com/lubrication):

**10160/2 EN**



## Gear pump unit

# OCU

### OCU models

Order number	Designation	Cooler	Flow rate		Rated power kW	Drive speed min <sup>-1</sup>	Dimensions mm	Weight kg
			l/min	pts/min				
13140907	SKF-OCU-5-P-400-XX	–	5	10.5	0,55	935	360×600×470	35
13140908	SKF-OCU-10-P-400-XX	–	10	21	0,75	1 450	360×600×470	33
13140909	SKF-OCU-30-P-400-XX	–	30	63	1,1	1 450	360×600×470	45
13140911	SKF-OCU-5-P-400-AIC	Air cooler	5	10.5	0,55	935	1 000×620×620	46
13140912	SKF-OCU-10-P-400-AIC	Air cooler	10	21	0,75	1 450	1 000×620×621	44
13140913	SKF-OCU-30-P-400-AIC	Air cooler	30	63	1,1	1 450	1 030×620×622	83
13140901	SKF-OCU-5-P-400-WAC	Water cooler	5	10.5	0,55	935	360×600×590	38
13140904	SKF-OCU-10-P-400-WAC	Water cooler	10	21	0,75	1 450	360×600×591	38
13140906	SKF-OCU-30-P-400-WAC	Water cooler	30	63	1,1	1 450	360×600×592	50

<sup>1)</sup> Other flow rates or motor voltages available on request.

## Screw pump unit

## Flowline



## Description

SKF Flowline oil supply units provide superior water and air separation properties. Their cylindrical stainless steel reservoirs typically require only one-third of the tank volumes of traditional oil tanks. Advanced technology and the unique SKF tank design guarantee the highest possible oil quality and condition. The compact and modular SKF Flowline oil circulation lubrication system product family consists of the following components: Flowline pumping unit, ST-2240 control centre, Flowline monitor flow meters and sump units.

## Features and benefits

- Increased machine availability due to optimal oil treatment
- Cost savings on oil purchasing, handling and disposal
- Energy savings
- Less environmental impact
- 50% reduction in reservoir size compared to traditional oil tanks
- 80% more air and water removal than traditional oil tanks
- 90% tank efficiency
- Short lead times

## Applications

- Pulp and paper industry
- Metals
- Mining
- Industrial gearboxes
- Industrial fans

## Technical data

Function	electrically operated screw pump unit
Lubricant	lubrication and hydraulic oils; viscosity 20 to 1 000 mm <sup>2</sup> /s
Flow rate	30 to 1 200 l/min; 8 to 317 gal/min
Ambient temperature	+10 to 40 °C; +50 to 104 °F
Oil temperature	+10 to 70 °C; +50 to 158 °F
Operating back pressure	max. 10 bar max. 145 psi
Motor	3-phase, according to DIN IEC 60038
Rated power	1,1 to 30 kW
Reservoir	300 up to 2 × 6 000 l 80 up to 2 × 1 585 gal
Material reservoir	stainless steel AISI 304 or AISI 316
Dimensions	depending on unit size
Mounting position:	
FL 300C to FL 2 000C	pump skid attached to the reservoir
FL 1 000 to FL 9000	pump skid on separate base frame



## NOTE

Further technical information, technical drawings, accessories, spare parts or product function descriptions are available on [SKF.com/lubrication](http://SKF.com/lubrication):

**17150 EN**







## Screw pump unit

## Streamline



## Description

SKF Streamline oil supply units are SKF's customized solution when it comes to oil circulation lubrication systems. They come with reservoir sizes of up to 40 000 liters in both carbon steel and stainless steel and provide equally superior water and air separation properties compared with the SKF Flowline product series. These reservoirs have a rectangular shape and typically require only one-third of the tank volumes of traditional oil tanks. Advanced technology and the unique SKF tank design guarantee the highest possible oil quality and condition.

## Features and benefits

- Increased machine availability due to optimal oil treatment
- Cost savings on oil purchasing, handling and disposal
- Energy savings
- Less environmental impact
- 50% reduction in reservoir size compared to traditional oil tanks
- 80% more air and water removal than traditional oil tanks
- 90% tank efficiency
- Dimensions can be adapted to machine footprint

## Applications

- Pulp and paper industry
- Metals
- Mining
- Industrial gearboxes

## Technical data

Function	electrically operated screw pump unit
Lubricant	hydraulic and lubricating oils; viscosity 20 to 1 000 mm <sup>2</sup> /s
Flow rate	30 to 4 000 l/min; 8 to 1 057 gal/min
Ambient temperature	0 to +70 °C; +32 to 158 °F
Oil temperature	+10 to 70 °C; +50 to 158 °F
Operating back pressure	max. 25 bar max. 363 psi
Rated power	1.1 to 75 kW
Reservoir	1 000–40 000 l 264–10 566 gal
Material reservoir	carbon steel or stainless steel AISI 304 or AISI 316
Dimensions	depending on unit size
Mounting position	pump skid mounting on separate base frame



## NOTE

For further technical information, technical drawings, accessories, spare parts or product function descriptions, please contact your local SKF sales representative.



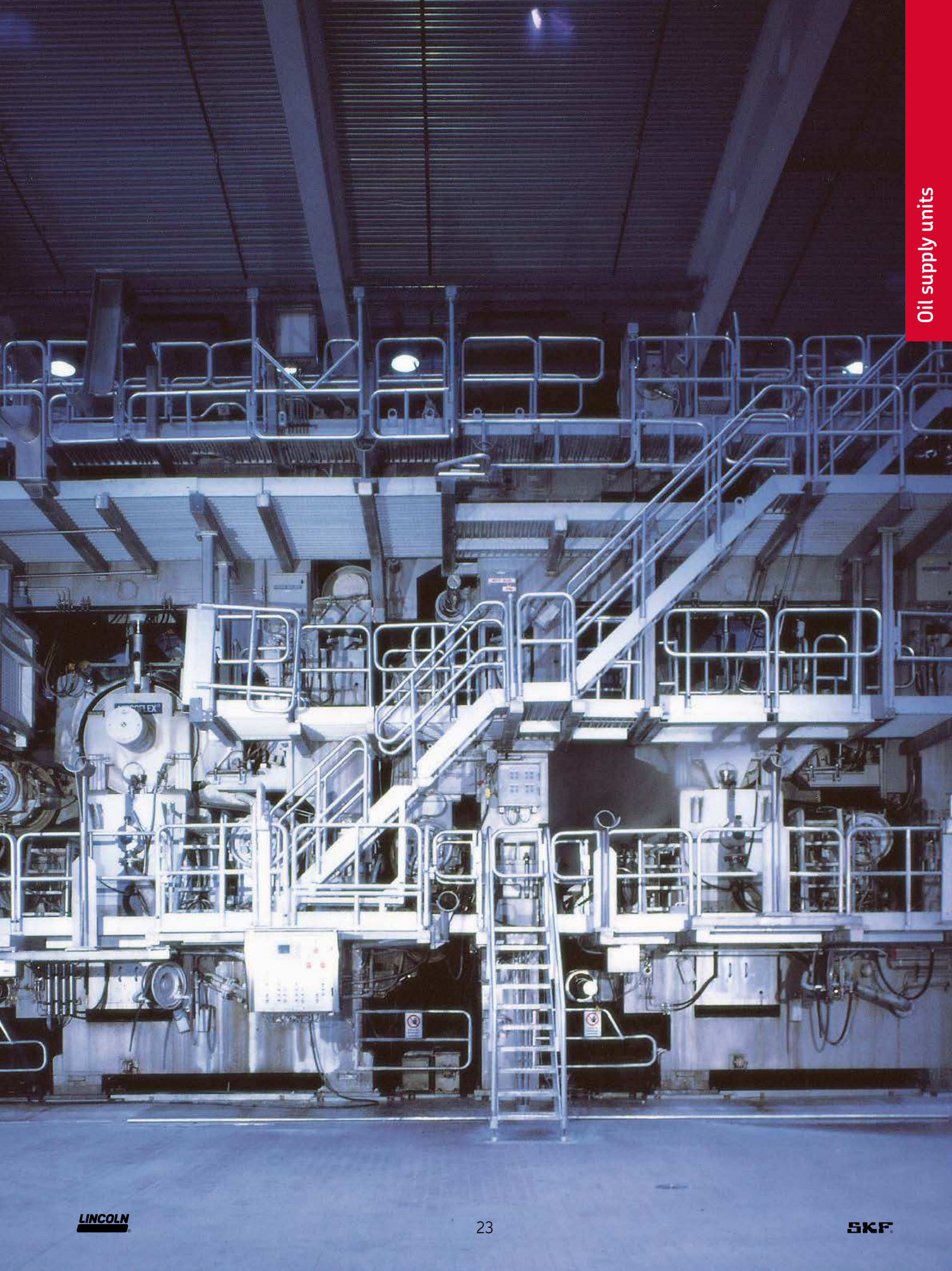





## Overview of oil circulation pumps

### Single-circuit oil pumps

Product	Function type	Outlets	Flow rate <sup>1)</sup> max.		Operating back pressure max.		Suction height max.		Page
			l/min	pts/min	bar	psi	mm	inch	
<b>M/MF</b>	gear pump	1	0,5	1.06	65	942	500	19.7	22
<b>FLM/FLMF</b>	vane pump	1	2,4	5.0	6	87	3 000	118.1	28
<b>ZP</b>	gear pump	1	2,5	5.3	25	363	1 000	39,4	30
<b>ZM (single-circuit)</b>	gear pump	1	2,5	5.3	30	435	1 000	39.4	32
<b>143</b>	gerotor pump	1	50	105.7	50	725	1 000	39.4	36
<b>143 EEX</b>	gerotor pump	1	50	105.7	50	725	1 000	39.4	38

<sup>1)</sup> Valid for operating viscosity of 140 mm<sup>2</sup>/s

### Multi-circuit oil pumps

Product	Function type	Outlets	Flow rate <sup>1)</sup> max.		Operating back pressure max.		Suction height max.		Page
			l/min	pts/min	bar	psi	mm	inch	
<b>ZM (multi-circuit)</b>	gear pump	2-20	0,45	0.951	20	290	500	19.7	40

<sup>1)</sup> Valid for operating viscosity of 140 mm<sup>2</sup>/s

### Hydrostatic oil pumps

Product	Function type	Outlets	Flow rate <sup>1)</sup> max.		Operating back pressure max.		Page
			l/min	pts/min	bar	psi	
<b>ZPU 09/09A</b>	piston pump	1-2	0,13	0.27	400	5 800	42

<sup>1)</sup> Valid for operating viscosity of 140 mm<sup>2</sup>/s

## Gear pump

### M/MF



#### Description

MF single-circuit gear pump units are used in small oil circulation lubrication systems with pressure ranges up to 65 bar (940 psi) and high viscosities up to 2 000 mm<sup>2</sup>/s. The pump is vertically mounted on the reservoir.

MF gear pumps come with integrated pressure relief and venting valves that feed into the internal return oil connection in the adapter flange. In case of trapped air, the venting valve opens. In case of excess pressure, oil is relieved to the return oil connection via the pressure relief valve.

#### Features and benefits

- Designed for 24/7 operation
- Inexpensive solution
- High viscosity range
- Compact, rugged and reliable design
- Low noise level
- Integrated pressure relief valve and venting valve

#### Applications

- Machine tools
- Automotive
- Automation
- Textile machinery
- Metal and plastic forming machinery
- Printing



#### Technical data

Function	electrically operated gear pump; single circuit
Lubricant	environmentally friendly mineral and synthetic oils; viscosity 5–2 000 mm <sup>2</sup> /s
Flow rate	0,12–0,5 l/min; 0,25–1,06 pts/min
Outlet	1
Operating temperature	+10 to 40 °C; +50 to 104 °F
Operating back pressure	max. 65 bar; max. 940 psi
Suction height	500 mm; 19.68 in
Drive speed	2 600–2 700 min <sup>-1</sup>
Motor <sup>1)</sup>	3-phase motor
Voltage	220–240/380–420 V AC at 50 Hz
Rated power	0,075–0,18 kW
Pressure connection	M 14 × 1,5 for Ø 8 mm
Suction connection	M 14 × 1,5 or M 16 × 1,5
Seal material	NBR, FPM
Protection class	IP 54
Dimensions	min. 131 × 88 × 209 mm max. 131 × 88 × 220 mm min. 5.16 × 3.54 × 8.23 in max. 5.16 × 3.54 × 8.66 in
Mounting position	horizontal <sup>2)</sup> or vertical
Approvals (dep. on model)	CE, UL, CSA

<sup>1)</sup> Further motor designs available on request.

<sup>2)</sup> with special seal design



#### NOTE

Further technical information, technical drawings, accessories, spare parts or product function descriptions available on [SKF.com/lubrication](http://SKF.com/lubrication):

**1-1204-2-EN, 951-170-001 EN, 951-170-002 EN**



# Gear pump

## M/MF

### M pumps for mounting separate from reservoir

Order number <sup>1)</sup>	Viscosity		Flow rate <sup>2)</sup>		Operating back pressure max.		Drive speed min <sup>-1</sup>	Rated power kW	Suction port thread mm	Weight	
	mm <sup>2</sup> /s	l/min	pts/min	bar	psi	kg				lbs	
<b>M1-2000+299</b>	20–2 000	0,12	0.253	28	406	2 700	0,075	M14×1,5	3,15	6.94	
<b>M2-2004+299</b>	20–2 000	0,2	0.423	12	174	2 700	0,075	M14×1,5	3,18	7.01	
<b>M2-2000+299</b>	20–2 000	0,2	0.423	28	406	2 700	0,075	M14×1,5	3,16	6.96	
<b>M2-S14+299</b>	20–1 000	0,2	0.423	65	940	2 700	0,075	M14×1,5	3,16	6.96	
<b>M2-2127+299</b>	20–2 000	0,2	0.423	70	1 015	2 700	0,075	M14×1,5	3,16	6.96	
<b>M5-2000+299</b>	20–1 000	0,5	1.06	28	406	2 700	0,075	M14×1,5	3,40	7.49	
<b>M5-2024+299</b>	20–2 000	0,5	1.06	25	362	2 700	0,075	M14×1,5	3,37	7.43	
<b>M5-2013+299</b>	5–500	0,5	1.06	16	230	2 700	0,075	M14×1,5	3,20	7.05	
<b>M5-S12+299</b>	35–500	0,5	1.06	60	870	2 700	0,120	M14×1,5	3,40	7.49	
<b>M10-2002+299</b>	10–500	1,0	2.12	15	217	2 700	0,075	M16×1,5	3,57	7.87	

### MF pumps for flange-mounting on reservoir

<b>MF1-2000+299</b>	20–2 000	0,12	0.253	28	406	2 700	0,075	M14×1,5	3,13	6.90
<b>MF1-2006+299</b>	20–2 000	0,12	0.253	6	87	2 700	0,075	M14×1,5	3,15	6.94
<b>MF2-2000+299</b>	20–2 000	0,2	0.423	28	406	2 700	0,075	M14×1,5	3,17	6.98
<b>MF2-S12+299</b>	20–1 000	0,2	0.423	65	940	2 800	0,120	M14×1,5	3,17	6.98
<b>MF2-2127+299</b>	140–1 000	0,2	0.423	60	870	2 700	0,075	M14×1,5	3,20	7.05
<b>MF5-2000+299</b>	20–1 000	0,5	1.06	28	406	2 700	0,075	M14×1,5	3,19	7.03
<b>MF5-2014+299</b>	5–500	0,5	1.06	12	174	2 700	0,075	M14×1,5	3,23	7.12
<b>MF5-S12+299</b>	140–1 000	0,5	1.06	60	870	2 800	0,075	M14×1,5	3,06	6.75
<b>MF10-2001+299</b>	20–1 000	1,0	2,11	12	174	2 700	0,075	M14×1,5	3,23	7.12
<b>MF10-S12+299</b>	20–1 000	1,0	2,11	28	406	2 800	0,120	M16×1,5	3,57	7.87
<b>MF210-2001+299</b>	20–150	2,0	4.22	15	217	2 700	0,075	M16×1,5	3,57	7.87

<sup>1)</sup> Recommended oil filtration for MF pumps: According to ISO 440620/17/14, NAS code (1638) class 8, SAW AS 4059 class 8

<sup>2)</sup> On an operating viscosity of 140 mm<sup>2</sup>/s and 5 bar back pressure

## Vane pump

# FLM/FLMF



### Description

The SKF FLM vane pump unit is a simple and very reliable solution suitable for usage in small oil circulation systems with low pressure and low viscosity range. Because of its high suction capacity of up to 3 m (the SKF FLM pump unit is often used as a sump pump). SKF Vane pumps can deliver both oil and oil/air mixtures and provide a higher suction capability than gear pump units. Two different pump designs of the pump unit are available, one allows the pump to be mounted separately from the reservoir (FLM) or the other allows the pump to be flange-mounted on the reservoir (FLMF) both vertically and horizontally. When installed on the side (horizontally), ensure that the unit is mounted above the maximum lubricant level. Special designs with a sealed flange for mounting below the lubricant level are available on request.

### Features and benefits

- Simple, reliable and cost-efficient solution
- Low-wear and low-maintenance
- High suction capacity (3 m)
- Designed for 24/7 operation
- Delivers oil and air mixtures
- Fail safe running functions

### Applications

- General industry
- Machine tools
- Automotive
- Automation

### Technical data

Function	electrically operated vane pump
Lubricant	mineral and synthetic oils; viscosity 20–850 mm <sup>2</sup> /s
Flow rate	1,2–2,4 l/min; 2,5–5,0 pts/min
Operating temperature	+10 to 40 °C; +50 to 104 °F
Operating back pressure	max. 3–6,6 bar; 44–87 psi
Suction height <sup>1)</sup>	1 000–3 000 mm; 39,4–118,1 in
E-motor drive	3 phase motor
Drive speed	2 700 min <sup>-1</sup>
Motor <sup>2)</sup>	3-phase motor
Voltage	220–240/380–420 V AC at 50 Hz
Rated output	0,075 kW
Suction connection	M16×1,5
Pressure connection	M14×1,5
Protection class	IP 54
Dimensions	max. 216 × 88 × 134,5 mm max. 8,5 × 3,46 × 5,29 in
Mounting position	separate or flanged to reservoir
Options	with shaft butt, with slotted coupling, left or right rotating pumps

<sup>1)</sup> Based on operating viscosity of 140 mm<sup>2</sup>/s at a back pressure of p = 5 bar.

<sup>2)</sup> Further motor designs available on request.



### NOTE

Further technical information, technical drawings, accessories, spare parts or product function descriptions available on [SKF.com/lubrication](http://SKF.com/lubrication):

**1-1204-2-EN, 951-170-001 –EN, 951-170-002 –EN**



3D

[skf-lubrication.partcommunity.com/3d-cad-models](http://skf-lubrication.partcommunity.com/3d-cad-models)

## Vane pump

# FLM/FLMF

### FLM / FLMF without reservoir

Order number		Flow rate <sup>1)</sup>		Suction height		Operating back pressure max.		Viscosity
flange-mounting	separate mounting	l/min	pts/min	mm	inch	bar	psi	mm <sup>2</sup> /s
<b>FLMF12-2000+299</b>	<b>FLM12-2000+299</b>	1,2	2.5	3 000	118.1	6,6	95	2–850
<b>FLMF24-2000+299</b>	<b>FLM24-2000+299</b>	2,4	5.0	3 000	118.1	3	44	2–500
<b>FLMF24-S10+299</b>	<b>FLM24-S10+299</b>	2,4	5.0	1 000	39.4	3	44	2–500

<sup>1)</sup> Recommended oil filtration for FLM/FLMF pumps: According to ISO 4406 20/17/14, NAS code (1638) class 8, SAWAS 4059 class 8

<sup>2)</sup> On an operating viscosity of 140 mm<sup>2</sup>/s and 5 bar back pressure



## Gear pump

# ZP



### Description

ZP gear pumps are manufactured for clockwise (ZP12-2; ZP1) or counterclockwise (ZP1-S1) rotation, with constant direction of delivery. The indicated delivery rates apply to an operating viscosity of 140 mm<sup>2</sup>/s and a back pressure of 5 bars (72 psi). They allow direct drive. ZP operated by electrical motors are ZM pumps.

### Features and benefits

- Designed for 24/7 operation
- Wide viscosity range
- Compact, rugged and reliable design
- Low noise level
- Integrated pressure relief valve and venting valve

### Applications

- Machine tools
- General industry
- Printing
- Metal forming

### Technical data

Function	gear pump
Lubricant	mineral and synthetic oils; viscosity 20–1 000 mm <sup>2</sup> /s
Flow rate:	
ZP12-2	1,2 l/min; 2,5 pts/l/min
ZP1; ZP1-S1	2,5 l/min; 5,3 pts/min
Operating temperature	+10 to +80 °C; +50 to 175 °F
Operating back pressure:	
ZP12-2	max. 25 bar; max. 363 psi
ZP1; ZP1-S1	max. 20 bar; max. 290 psi
Suction height: <sup>1)</sup>	
ZP12-2	500 mm; 19,7 in
ZP1; ZP1-S1	1 000 mm; 39,4 in
Drive direction: <sup>2)</sup>	
ZP12-2; ZP1	clockwise
ZP1-S1	counterclockwise
Connection suction	M12×1
Pressure connection	M12×1
Dimensions	min. 60 × 60 × 85 mm max. 70 × 70 × 82 mm min. 2.36 × 2.36 × 3.35 in max. 2.76 × 2.76 × 3.23 in with shaft butt, with slotted coupling, clockwise or counterclockwise rotating pumps
Designs	

<sup>1)</sup> At 1 400 min<sup>-1</sup>

<sup>2)</sup> Viewing on drive shaft



### NOTE

Further technical information, technical drawings, accessories, spare parts or product function descriptions available on [SKF.com/lubrication](http://SKF.com/lubrication):

**1-1200-EN**



3D

[skf-lubrication.partcommunity.com/3d-cad-models](http://skf-lubrication.partcommunity.com/3d-cad-models)

## Gear pump

# ZP

### ZP

Order number	Flow rate <sup>1)</sup> at 1 400 min <sup>-1</sup>		Back pressure max.		Suction head <sup>1)</sup>		Direction of rotation <sup>2)</sup>
	l/min	pts/min	bar	psi	mm	in	
<b>ZP12-2</b> <sup>3)</sup>	1,2	2.5	25	363	500	19.7	right
<b>ZP1</b> <sup>3)</sup>	2,5	5.3	20	290	1 000	39.4	right
<b>ZP1-S1</b> <sup>3)</sup>	2,5	5.3	20	290	1 000	39.4	left

- <sup>1)</sup> with open main line at 1 400 min<sup>-1</sup> and oil viscosity of 140 mm<sup>2</sup>/min  
<sup>2)</sup> viewing on the drive shaft  
<sup>3)</sup> order adapter with ports tapped for solderless tube connection separately

## Gear pump

# ZM (single-circuit)



### Description

ZM single-circuit gear pump units are used in small oil circulation lubrication systems with pressure ranges up to 30 bar (435 psi) and high viscosities up to 2 000 mm<sup>2</sup>/s. They consist of a gear pump, a flange, a coupling and an electric motor. The pump design suits mounting separately from the reservoir or vertically on top of the reservoir. Horizontal flange mounting below lubricant level is not allowed. ZM gear pump units come without integrated pressure relief and venting valves.

### Features and benefits

- High viscosity range
- Low noise operation
- High operating back pressure
- Easy system planning

### Applications

- Machine tools
- Metal and plastic forming machinery
- General industry

### Technical data

Function	electrically operated gear pump
Lubricant	mineral and synthetic oils; viscosity: 20–2 000 mm <sup>2</sup> /s
Flow rate	
ZM12:	1,2 l/min; 2,5 pts/min
ZM25:	2,5 l/min; 5,3 pts/min
Outlets	1
Operating temperature	+10 to 40 °C; +50 to 104 °F
Operating back pressure:	
ZM12	max. 30 bar; max. 435 psi
ZM25	max. 20 bar; max. 290 psi
Suction height:	
ZM12	500 mm; 19.7 in
ZM25	1 000 mm; 39.4 in
Drive speed	1 350 min <sup>-1</sup>
Motor <sup>1)</sup>	3-phase motor
Voltage	220–240/380–420 V AC at 50 Hz
Rated power	0,18 kW
Pressure connection	G 1/4; M14×1,5
Suction connection	G 1/4; M16×1,5
Protection class	IP 54
Dimensions:	
ZM12	299 × 164 × 125 mm; 11.77 × 6.45 × 4.92 in
ZM25	283 × 123 × 162 mm; 11.14 × 4.84 × 6.37 in
Mounting position	horizontal or vertical

<sup>1)</sup> Further motor designs available on request.



### NOTE

Further technical information, technical drawings, accessories, spare parts or product function descriptions available on [SKF.com/lubrication](http://SKF.com/lubrication):  
**1-1204-2-EN; 951-170-002 EN**



## Gear pump

# ZM (single-circuit)

### ZM single-circuit<sup>1)</sup>

Order number	Design	Mounting position	Flow rate <sup>2)</sup>		Operating back pressure max.	
			<i>l/min</i>	<i>pts/min</i>	<i>bar</i>	<i>psi</i>
<b>ZM12-21+1FV</b>	foot design, CE Europe	horizontal, separate	1.2	2.5	30	435
<b>ZM12-31+1FV</b>	flange design, CE Europe	vertical, flanged	1.2	2.5	30	435
<b>ZM12-21-S11+1HM</b>	foot design, UL/CSA (USA, Canada)	horizontal, separate	1.2	2.5	30	435
<b>ZM25-2+1FV</b>	foot design, CE Europe	horizontal, separate	2.5	5.3	20	290

<sup>1)</sup> Recommended filtration for ZM single-circuit pumps according to: ISO 4406 20/17/14; NAS code (1638); class 8 SAW AS 4059 class 8

<sup>2)</sup> On an operating viscosity of 140 mm<sup>2</sup>/s and 5 bar back pressure

## Gerotor pump

## 143 without motor



## Description

Gerotor pump series 143 are self-priming positive-displacement pumps with fixed displacement and high efficiency. They are suitable for a variety of applications, such as hydraulic, hydrostatic, cooling as well as circulating-oil and total-loss lubrication systems. SKF gerotor pump units of product series 143 are highly efficient and operate in a flow range between 0,85 to 50 l/min at pressure up to 50 bar. They are characterized by very smooth running, low noise generation and good suction capability.

## Features and benefits

- Flexible pump delivery range
- Wide viscosity range
- Smooth running
- Low-noise operation
- Good suction characteristics
- Simplified ordering

## Applications

- Marine and offshore industry
- Pulp and paper and printing industries
- Commercial vehicles
- Heavy industry



## Technical data

Function	gerotor pump
Lubricant	lubrication and hydraulic oils; viscosity 20 to 1 000 mm <sup>2</sup> /s
Flow rate	0,85–50 l/min; 1.8–105.7 pts/min
Operating temperature	0 to +40 °C; +32 to 104 °F
Operating back pressure	max. 50 bar; max. 725 psi
Outlet	1
Suction height	max. 1 000 mm; 39.4 in
Drive speed	1 400–2 800 min <sup>-1</sup>
Connecting thread pressure	G 1/4 to G 1 BSPP
Connecting thread suction	G 1/4 to G 1 1/4 BSPP
Material	hydraulic cast, steel, sintered material, low-deformation case-hardened steels, NBR or FPM
Dimensions	depending on the model: min. 289 × 184 × 126 mm max. 656 × 264 × 280 mm min. 11.37 × 7.3 × 4.96 in max. 25.82 × 10.4 × 11 in
Mounting position	horizontal or vertical; foot or flange mounting.



## NOTE

Further technical information, technical drawings, accessories, spare parts or product function descriptions available on [SKF.com/lubrication](http://SKF.com/lubrication):

**1-1204-3-EN, 951-170-222-EN**



## 3D

[skf-lubrication.partcommunity.com/3d-cad-models](http://skf-lubrication.partcommunity.com/3d-cad-models)

# Gerotor pump

## 143 without motor

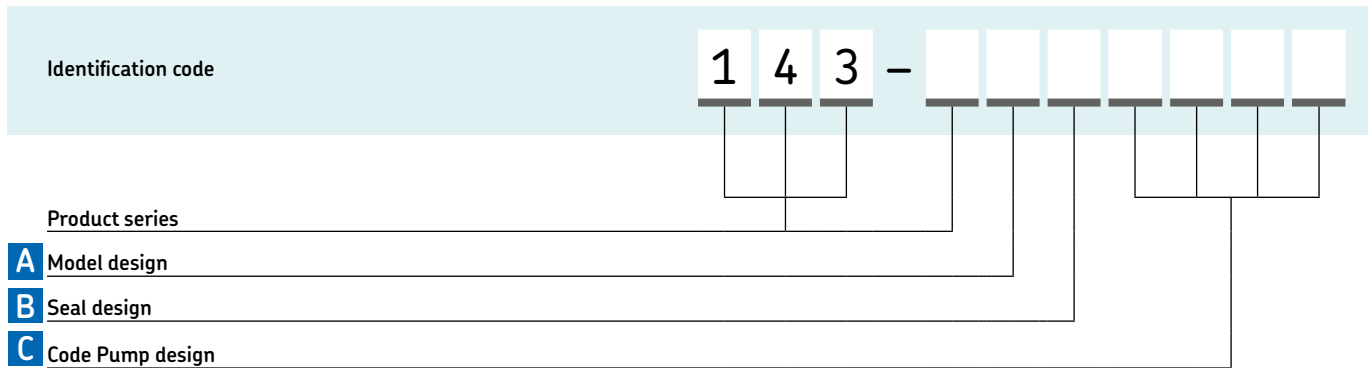

### Model design

- A** 3 gerotor pump+pump flange+ shaft coupling
- 4 gerotor pump only

### Seal design

- B** N NBR
- F FKM

### Pump design

Code	Flow rate <sup>1)</sup>		Operating back pressure max.		Code	Flow rate <sup>1)</sup>		Operating back pressure max.	
	l/min	pts/min	bar	psi		l/min	pts/min	bar	psi
<b>D03</b>	1.7	3.6	30	435	<b>M05</b>	12,5	26.4	50	725
<b>F02</b>	2.5	5.3	20	290	<b>P02</b>	19	40.1	20	290
<b>F05</b>	2.5	5.3	50	725	<b>R02</b>	30	63.4	20	290
<b>H02</b>	5.25	11.1	20	290	<b>R03</b>	30	63.4	30	435
<b>H05</b>	5.25	11.1	50	725	<b>T02</b>	40	84.5	20	290
<b>K02</b>	9	19	20	290	<b>T03</b>	40	84.5	30	435
<b>K05</b>	9	19	50	725	<b>V02</b>	50	105.7	20	290
<b>M02</b>	12.5	26.4	20	290	<b>V03</b>	50	105.7	30	435

<sup>1)</sup> Valid for operating viscosity of 140 mm<sup>2</sup>/s

## Accessories

### Pressure relief valves

Order number	Flow rate	
	l/min	pts/min
<b>WVN200-10</b>	1,7; 2,5; 5,25	3,6; 5,3; 11,1
<b>161-218-000</b>	9; 12,5	19; 26,4
<b>161-228-051</b>	19; 30; 40; 50	40,2; 63,4; 84,5; 105,7

## Gerotor pump

## 143 with motor



## Description

Gerotor pump series 143 are self-priming positive-displacement pumps with fixed displacement and high efficiency. They are suitable for a variety of tasks and applications, such as circulating-oil and total-loss lubrication systems. SKF gerotor pumps operate in a flow range between 0,85 to 50 l/min at pressure up to 50 bar. They are characterized by very smooth running, low noise generation and good suction capability.

## Features and benefits

- Flexible pump delivery range
- Wide viscosity range
- Smooth running
- Low-noise operation
- Good suction characteristics
- Simplified ordering

## Applications

- Marine and offshore industry
- Pulp and paper and printing industries
- Heavy industry

## Technical data

Function	electrically operated gerotor pump
Lubricant	lubrication and hydraulic oils; viscosity 20 to 1 000 mm <sup>2</sup> /s
Flow rate	0,85–50 l/min; 1,8–105 pts/min
Operating temperature	0 to +40 °C; +32 to 104 °F
Operating back pressure	max. 50 bar; max. 725 psi
Outlet	1
Suction height	max. 1 000 mm; 39,4 in
Operating voltage	3-phase, acc. to DIN IEC 60038
Drive speed	1 400–2 800 min <sup>-1</sup>
Connecting thread pressure	G 1/4 to G 1 BSPP
Connecting thread suction	G 1/4 to G 1 1/4 BSPP
Rated power	0,18 to 5,5 kW
Protection class	IP 54 (motor)
Material	hydraulic cast, steel, sintered material, low-deformation case-hardened steels, NBR or FPM
Dimensions	depending on the model: min. 289 × 184 × 126 mm max. 656 × 264 × 280 mm min. 11,37 × 7,3 × 4,96 in max. 25,82 × 10,4 × 11 in
Mounting position	horizontal or vertical; foot or flange mounting



## NOTE

Further technical information, technical drawings, accessories, spare parts or product function descriptions available on [SKF.com/lubrication](http://SKF.com/lubrication):

**1-1204-3-EN**



3D

[skf-lubrication.partcommunity.com/3d-cad-models](http://skf-lubrication.partcommunity.com/3d-cad-models)



# Gerotor pump

## 143 with motor

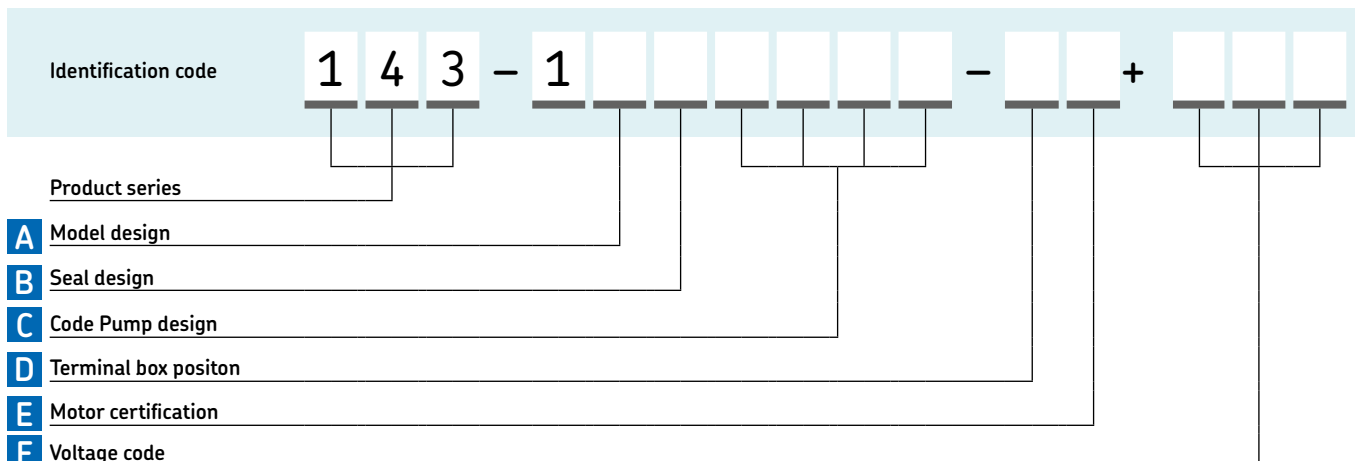

### Model design

- A** 1 Motor foot (IBM34)
- 2 Motor flange (IBM14)
- 3 Gerotor pump+pump flange+ shaft coupling (without motor)
- 4 only gerotor pump (without motor)

### Seal design

- B** N NBR
- F FKM

### Terminal box position

as seen from shaft extension of drive side (not applicable on design without motor)

- D** R right, (standard, not on motor 1.1; 1.5, and 4 kW)
- O top (standard, on motor 1.1, 1.5, and 4 kW)
- X on motor flange design (IBM14), terminal box position on suction port side of pump

(others available on request)

### Motor certification

- E** A CE (Europe)
  - B UL/CSA (USA/Canada)
- (others available on request)

### Pump design

C Code	Metering quantity <sup>1)</sup>	Operating pressure	Motor drive	Operating viscosity	Size	Poles
	l/min	max. bar	kW	mm <sup>2</sup> /s		
B03C	0,85	30	0,18	20–1 000	63	4
D03E	1,7	30	0,37	20–1 000	71	2
F02D	2,5	20	0,25	20–1 000	71	4
F05F	2,5	20	0,55	20–1 000	80	4
H02F	5,25	20	0,55	20–1 000	80	4
H05J	5,25	50	1,1	20–1 000	90	4
K02H	9	20	0,75	20–1 000	80	4
K05J	9	50	1,1	20–1 000	90	4
M02H	12,5	20	0,75	20–1 000	80	4
M05K	12,5	50	1,5	20–1 000	90	4
P02K	19	20	1,5	20–1 000	90	4
R02M	30	20	3	20–1 000	100	2
R03M	30	30	3	20–750	100	2
R03N	30	30	4	20–1 000	112	2
T02M	40	20	3	20–750	100	2
T03N	40	30	4	20–1 000	112	2
V02N	50	20	4	20–1 000	112	2
V03N	50	30	4	20–750	112	2
V03P	50	30	5,5	20–1 000	132	2

<sup>1)</sup> Nominal flow rate at motor speed 1 400/2 800 min<sup>-1</sup> according to number of motor pins.

### Voltage Code V AC

- F** +1GP 220/380<sup>1)</sup>, 255/440<sup>2) 3)</sup>
- +1GD 230/400<sup>1)</sup>; 265/460<sup>2) 3)</sup>
- +1GQ 240/415<sup>1)</sup>; 280/480<sup>2) 3)</sup>
- +1HQ 290/500<sup>1)</sup>; 330/575<sup>2) 3)</sup>
- +1GH 380/660<sup>1)</sup>; 440<sup>2) 3)</sup>
- +1GK 400/690<sup>1)</sup>; 460<sup>2) 3)</sup>
- +1GL 415/720<sup>1)</sup>; 480<sup>2) 3)</sup>
- +1KG 400<sup>1)</sup>; 460<sup>2) 3)</sup>
- +1KS 240/415<sup>2)</sup>
- +1LL 500/575<sup>1) 2)</sup>
- +1GF 200/345<sup>1) 3)</sup>
- +1GG 200/345<sup>2) 3)</sup>
- +MDP 220/380<sup>2) 3)</sup>
- +MFN 255/440<sup>1)</sup>
- +1GR 230/400<sup>2) 3)</sup>
- +MMP 305/525<sup>1) 3)</sup>
- +1FX 220–240/380–420<sup>1) 4)</sup>  
254–240/440–480<sup>2) 4)</sup>
- +1HM 220–240/380–420<sup>1) 4)</sup>  
254–280/440–480<sup>2) 4)</sup>

<sup>1)</sup> 50 Hz  
<sup>2)</sup> 60 Hz  
<sup>3)</sup> ±10 %  
<sup>4)</sup> ±5 %

## Gerotor pump

## 143 EEX



## Description

The SKF 143 EEX product series was designed for centralized lubrication systems in explosive environments. It offers a high degree of protection in explosive atmospheres. Pump, motor, coupling and seals comply with ATEX requirements. SKF Gerotor pumps of the 143 series are self-priming positive displacement pumps with a fixed displacement and high efficiency. They are suitable for lubrication, hydraulic, hydrostatic and cooling applications as well as for oil circulation lubrication systems.

## Features and benefits

- Safe operation in explosive environments (Zone 1, 2, 21, 22)
- Work with standard mineral and synthetic lubrication and hydraulic oils
- Smooth running
- Good suction characteristic
- Low noise

## Applications

- Marine and offshore industry
- Pulp and paper and printing industries
- Wood industry
- Heavy industry
- Agriculture

## Technical data

Function	electrically operated gerotor pump
Lubricant	lubrication and hydraulic oils; viscosity 20 to 1 000 mm <sup>2</sup> /s
Flow rate	0,85–50 l/min; 1.8–105 pts/min
Operating temperature	0 to 40 °C; 32 to 104 °F
Operating back pressure	depending on model; max. 50 bar; max. 725 psi
Outlet	1
Suction height	max. 1 000 mm; 39.4 in
Motor	3-phase, acc. to DIN IEC 60038
Output rated	0,18–5,5 kW
Drive speed	1 400–2 800 min <sup>-1</sup>
Connecting thread pressure	G 1/4 to G 1 BSPP
Connecting thread suction	G 1/4 to G 1 1/4 BSPP
Rated power	0,25 to 5,5 kW
Protection class	IP 54
Material	hydraulic cast, steel, sintered material, low-deformation case-hardened steels, NBR or FPM
Dimensions	depending on the model: min. 289 × 184 × 126 mm max. 656 × 264 × 280 mm min. 11.37 × 7.3 × 4.96 in max. 25.82 × 10.4 × 11 in
Mounting position	horizontal or vertical; foot or flange mounting.
ATEX gas	II 2G c IICT 4 Gb
ATEX dust	II 2D c IIIC T120° C Db



## NOTE

Further technical information, technical drawings, accessories, spare parts or product function descriptions available on [SKF.com/lubrication](http://SKF.com/lubrication):

17345 EN; 915-170-002



## 3D

[skf-lubrication.partcommunity.com/3d-cad-models](http://skf-lubrication.partcommunity.com/3d-cad-models)

# Gerotor pump

## 143 EEX

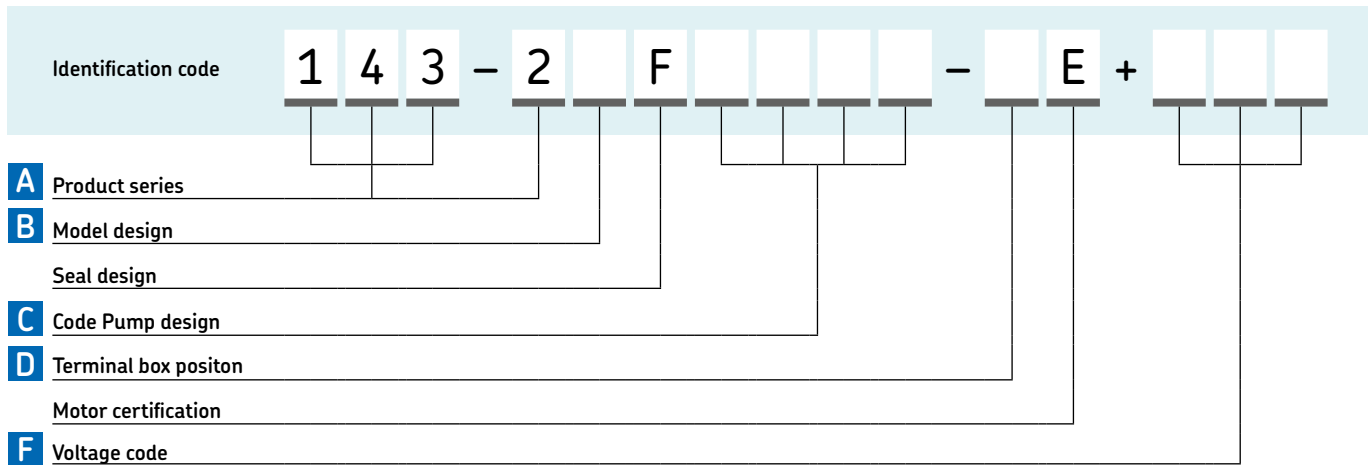

### Model design

- A** 1 motor foot (IBM34)
- 2 motor flange (IBM14)

### Seal design

- B** F FKM

### Terminal box position

as seen from shaft extension of drive side

- D** R right, (standard, not on motor 1.1; 1.5, and 4 kW)
- O top (standard, on motor 1.1, 1.5, and 4 kW)
- X on motor flange design (IBM14), terminal box position on suction port side of pump

(others available on request)

### Motor certification

- E** E ATEX; IECEx

### Pump design

C Code	Flow rate <sup>1)</sup>	Operating pressure	Motor drive	Operating viscosity	Size	Poles
	l/min	max. bar	kW	mm <sup>2</sup> /s		
B03C	0,85	30	0,18	20–1 000	63	4
D03E	1,7	30	0,37	20–1 000	71	2
F02D	2,5	20	0,25	20–1 000	71	4
F05F	2,5	20	0,55	20–1 000	80	4
H02F	5,25	20	0,55	20–1 000	80	4
H05J	5,25	50	1,1	20–1 000	90	4
K02H	9	20	0,75	20–1 000	80	4
K05J	9	50	1,1	20–1 000	90	4
M02H	12,5	20	0,75	20–1 000	80	4
M05K	12,5	50	1,5	20–1 000	90	4
P02K	19	20	1,5	20–1 000	90	4
R02M	30	20	3	20–1 000	100	2
R03M	30	30	3	20–750	100	2
R03N	30	30	4	20–1 000	112	2
T02M	40	20	3	20–750	100	2
T03N	40	30	4	20–1 000	112	2
V02N	50	20	4	20–1 000	112	2
V03N	50	30	4	20–750	112	2
V03P	50	30	5,5	20–1 000	132	2

<sup>1)</sup> Nominal delivery rate at motor speed 1 400/2 800 min<sup>-1</sup> according to number of motor pins.

### Voltage Code VAC

- F** +1GP 220/380 <sup>1)</sup>, 255/440 <sup>2) 3)</sup>
- +1GD 230/400 <sup>1)</sup>; 265/460 <sup>2) 3)</sup>
- +1GQ 240/415 <sup>1)</sup>; 280/480 <sup>2) 3)</sup>
- +1HQ 290/500 <sup>1)</sup>; 330/575 <sup>2) 3)</sup>
- +1GH 380/660 <sup>1)</sup>; 440 <sup>2) 3)</sup>
- +1GK 400/690 <sup>1)</sup>; 460 <sup>2) 3)</sup>
- +1GL 415/720 <sup>1)</sup>; 480 <sup>2) 3)</sup>
- +1KG 400 <sup>1)</sup>; 460 <sup>2) 3)</sup>
- +1GF 200/345 <sup>1) 3)</sup>
- +1GG 200/345 <sup>2) 3)</sup>
- +MDP 220/380 <sup>2) 3)</sup>
- +1GR 230/400 <sup>2) 3)</sup>
- +MMP 305/525 <sup>1) 3)</sup>
- +1FX 220–240/380–420 <sup>1) 4)</sup>
- 254–240/440–480 <sup>2) 4)</sup>
- +1HM 220–240/380–420 <sup>1) 4)</sup>
- 254–280/440–480 <sup>2) 4)</sup>

<sup>1)</sup> at 50 Hz  
<sup>2)</sup> at 60 Hz  
<sup>3)</sup> ±10 %  
<sup>4)</sup> ±5 %

## Gear pump

# ZM (multi-circuit)



### Description

ZM multi-circuit gear pump units are self-priming and valveless pumps. They are used in oil circulation lubrication systems with 2 to 20 separate delivery circuits. Unused outlets must be returned to the reservoir. The pumps consists of an electric motor, adapter flange, coupling and a gear pump. The pump can be mounted separately from the reservoir or as a flanged pump on the reservoir. A special design with seals for horizontal mounting below lubricant level is available. The fluids to be pumped must have enough lubricity for the pump to lubricate itself.

Some of these distribution pumps require an attached, single-circuit priming pump that operates separately. The priming pump restricts differential pressure within the multicircuit pumps and helps to provide uniform delivery rates. It is advisable to filter the oil upstream of the distribution pump inlet.

### Features and benefits

- High viscosity range
- Flexible due to up to 20 circuits per pump
- Suitable for hydrostatic operation
- Easy system planning
- Space-saving pump design

### Applications

- Machine tools
- Metal and plastic forming machinery
- General industry

### Technical data

Function	electrically operated, self-priming gear pump
Lubricant	mineral and synthetic oils; viscosity depending on model: 20–2 000 mm <sup>2</sup> /s
Flow rate	depending on model: min. 0,015 l/min; 0.032 pts/min max. 0,45 l/min; 0.951 pts/min
Outlets	2–20
Operating temperature	+10 to 40 °C; +50 to 104 °F
Operating back pressure	max. 20 bar; max. 290 psi
Suction height	500 mm; max. 19.7 in
Drive speed	670 to 1 400 min <sup>-1</sup>
Motor	3-phase motor
Voltage	220–240/380–420 V AC at 50 Hz
Rated power	0,18–0,37 kW
Pressure connection	G 1/8 or M10×1
Suction connection	G 1/2 or M14×1,5
ZM21 ... , ZM50 ... :	M14×1,5 for Ø12 mm
ZM10 ... :	G 1/2
Material sealing	NBR, FPM
Protection class	IP 54
Dimensions	min. 325 × 152 × 125 mm max. 460 × 208 × 160,5 mm min. 12.79 × 5.98 × 4.92 in max. 18.11 × 8.18 × 6.32 in
Mounting position	horizontal, or flanged to reservoir <sup>1)</sup>

<sup>1)</sup> Only flange design version with separate seal



### NOTE

Further technical information, technical drawings, accessories, spare parts or product function descriptions available on [SKF.com/lubrication](http://SKF.com/lubrication):  
**1-1204-2-EN, 951-170-002 EN**



## Gear pump

# ZM (multi-circuit)

### ZM multi-circuit pump, self-priming <sup>1)</sup>

Order number	Circuits <sup>4)</sup> (Outlets)	Flow rate <sup>6)</sup> V <sub>a</sub>		V <sub>b</sub>		Back pressure		Drive speed min <sup>-1</sup>	Operating viscosity mm <sup>2</sup> /s
		l/min	pts/min	l/min	pts/min	bar	psi		
ZM212-21+1FV <sup>2)</sup>	2	1×0,12	1×0.253	1×0,12	1×0.253	12	174	1 300	20–2 000
ZM212-31+1FV <sup>3)</sup>	2	1×0,12	1×0.253	1×0,12	1×0.253	12	174	1 300	20–2 000
ZM502+1FV <sup>2)</sup>	5	5×0,2	5×0.423	-	-	20	290	670	20–2 000
ZM502-3+1FV <sup>3)</sup>	5	5×0,2	5×0.423	-	-	20	290	670	20–2 000
ZM505+1FV <sup>2)</sup>	5	5×0,45	5×0.951	-	-	10	145	670	20–500
ZM505-3+1FV <sup>3)</sup>	5	5×0,45	5×0.951	-	-	10	145	670	20–500
ZM1002+1FV <sup>2)</sup>	10	5×0,2	5×0.423	5×0,2	5×0.423	20	290	690	20–1 000
ZM1002-3+1FV <sup>3)</sup>	10	5×0,2	5×0.423	5×0,2	5×0.423	20	290	690	20–1 000
ZM1005+1FV <sup>2)</sup>	10	5×0,45	5×0.951	5×0,45	5×0.951	10	145	690	20–250
ZM1005-3+1FV <sup>3)</sup>	10	5×0,45	5×0.951	5×0,45	5×0.951	10	145	690	20–250
ZM1025+1FV <sup>2)</sup>	10	5×0,2	5×0.423	5×0,45	5×0.951	15	218	690	20–500
ZM1025-3+1FV <sup>3)</sup>	10	5×0,2	5×0.423	5×0,45	5×0.951	15	218	690	20–500

### ZM multi-circuit pump for operation with a separate priming pump <sup>1)</sup>

Order number	Circuits <sup>4)</sup> (Outlets)	Flow rate <sup>6)</sup> V <sub>a</sub>		V <sub>b</sub>		Pump inlet P <sub>1</sub> <sup>5)</sup>		Drive speed min <sup>-1</sup>	Operating viscosity mm <sup>2</sup> /s
		l/min	pts/min	l/min	pts/min	bar	psi		
ZM402-2-S2+1FV <sup>2)</sup>	4	4×0,2	4×0.423	-	-	50	725	690	20–500
ZM405-2-S2+1FV <sup>2)</sup>	4	4×0,45	4×0.951	-	-	50	725	690	20–500
ZM502-S2+1FV <sup>2)</sup>	5	5×0,2	5×0.423	-	-	30	435	690	20–500
ZM505-S2+1FV <sup>2)</sup>	5	5×0,45	5×0.951	-	-	30	435	690	20–500
ZM802-2-S2+1FV <sup>2)</sup>	8	4×0,2	4×0.423	4×0,2	4×0.423	50	725	690	20–500
ZM805-2-S2+1FV <sup>2)</sup>	8	4×0,45	4×0.951	4×0,45	4×0.951	50	725	690	20–500
ZM1002-S2+1FV <sup>2)</sup>	10	5×0,2	5×0.423	5×0,2	5×0.423	30	435	690	20–500
ZM1005-S2+1FV <sup>2)</sup>	10	5×0,45	5×0.951	5×0,45	5×0.951	30	435	690	20–500
ZM2101-1+1FV <sup>2)</sup>	20	20×0,015	20×0.032	-	-	30	435	1 400	20–1 000
ZM2102-1+1FV <sup>2)</sup>	20	20×0,03	20×0.063	-	-	30	435	1 400	20–1 000
ZM2103-1+1FV <sup>2)</sup>	20	20×0,05	20×0.105	-	-	30	435	1 400	20–1 000
ZM2104-1+1FV <sup>2)</sup>	20	20×0,1	20×0.211	-	-	30	435	1 400	20–1 000

### ZM pump with built-in priming pump and adjustable pressure restriction valve <sup>1)</sup>

Order number	Circuits <sup>4)</sup> (Outlets)	Flow rate <sup>6)</sup>		Pump inlet P <sub>1</sub>		Pump inlet P <sub>2</sub>		Drive speed min <sup>-1</sup>
		l/min	pts/min	bar	psi	bar	psi	
ZM1035+1FV <sup>2)</sup>	10	10×0,45	10×0.951	16	232	20	290	1 400
ZM2201+1FV <sup>2)</sup>	20	20×0,025	20×0.052	18	260	20	290	680
ZM2202+1FV <sup>2)</sup>	20	20×0,035	20×0.074	18	260	20	290	915
ZM2103+1FV <sup>2)</sup>	20	20×0,05	20×0.105	18	260	20	290	1 360

<sup>1)</sup> Recommended filtration between multicircuit pump and priming pump. According to: ISO 4406 20/17/14, NAS code (1638) class 8, SAW AS 4059 class 8

<sup>2)</sup> Foot-mounted pumps for separate mounting from reservoir

<sup>3)</sup> Flange-mounted pumps with special seal design

<sup>4)</sup> Non used pump delivery ports must be returned to the oil reservoir and must **not** be blanked off

<sup>5)</sup> P2 outlet pressure corresponds P1 ± 5 bar; 72,5 psi

<sup>6)</sup> Valid for an operation viscosity of 140 mm<sup>2</sup>/min and a drive speed of 1 400 min<sup>-1</sup>

## Piston pump

# ZPU 09/09A



### Description

The ZPU 09/09A high-pressure pumps are designed for use in hydrostatic and hydrodynamic (start-up phase) lubrication systems. They also may be used in oil supply systems, blocking oil systems and regulation and control oil systems. The pump is suitable for oils with viscosity of 20 to 460 mm<sup>2</sup>/s. The pump shows a housing, of 8 l (16.9 pts) capacity, with a pump element and a flange with outlets and return lines, all connected to a 3-phase, multi-range or 500 V motor. The pump can be delivered with one or two outlets.

### Features and benefits

- Reliable
- With one or two outlets
- Simple to service
- Built-in check-valve for ZPU 09
- Return line from pressure relief valve
- Housing integrated oil level indicator

### Applications

- Turbines
- Steel mills
- Gears
- Paper machines
- Power stations

### Technical data

Function	electrically operated piston pump
Operating temperature	-20 to +80 °C; -4 to +176 °F
Operating back pressure	max. 400 bar; max. 5 800 psi
Lubricant	mineral and synthetic oils; viscosity 20–460 mm <sup>2</sup> /s
Number of outlets	
ZPU09	1
ZPU09A	2
Flow rate	
ZPU09	0,13 l/min, 0.27 pts/min
ZPU09A	2 × 0,06 l/min, 2 × 0.13 pts/min
Voltage	380–415, 420–480 V AC / 50 Hz, ±5% to ±10% 500 V AC / 50 Hz, ±10%
Outlet connection filling line	G 3/8 BSPP
Direction of rotation drive	optional
Protection class	IP 54
Dimensions	650 × 410 × 465 mm 25.59 × 16.14 × 16.31 in
Mounting position	vertical

## Piston pump

# ZPU 09/09A

### ZPU 09/09A

Order number	Designation	Number of outlets	Flow rate per outlet		Motor
			l/min	pts/min	
605-27545-1	ZPU 09 / 08 GT-380-415, 420-480	1	0,13	0.27	3-phase gear motor, 380-415 / 420-480 V AC
605-27546-1	ZPU09 / 08GT-500	1	0,13	0.27	3-phase gear motor, 500 V AC
605-27547-1	ZPU09A / 08GT-380-415,420-480	2	0,6	0.13	3-phase gear motor, 380-415 / 420-480 V AC
605-27548-1	ZPU09A / 08GT-500	2	0,6	0.13	3-phase gear motor, 500 V AC
605-28166-1	ZPU09 / 08GT-000	1	0,13	0.27	without motor





## Overview of oil circulation metering devices

### Flow restrictor

Product	Lubricant viscosity	Flow rate		Outlets	Operating pressure max.		Operating temperature		Page
		mm <sup>2</sup> /s	l/min		pts/min	bar	psi	°C	
<b>VD</b>	10–1 000	0,001–0,23	0.002–0.49	1	max. 10	max. 145	0 to 60	32 to 140	48

### Flow divider

Product	Lubricant viscosity	Flow rate		Outlets	Operating pressure max.		Operating temperature		Page
		mm <sup>2</sup> /s	l/min		pts/min	bar	psi	°C	
<b>SMT</b>	50–1 300	0,5–6,0	1.1–12.7	2	100	1 450	0 to +100	32 to 212	50

### Adjustable metering valve with visual flow indication

Product	Lubricant viscosity	Flow rate		Outlets	Operating pressure max.		Operating temperature		Page
		mm <sup>2</sup> /s	l/min;		pts/min	bar	psi	°C	
<b>242 type A</b>	10–1 000	0–0,01	0–0.02	1, 2, 5, 14	10	145	0 to 60	32 to 140	52
<b>242 type B</b>	10–1 000	0,01–1,0	0.02–2.1	2–6, 10, 12	10	145	0 to 60	32 to 140	52
<b>242 type C</b>	10–1 000	0,01–2,0	0.02–4.2	2–6	10	145	0 to 60	32 to 140	52

### Adjustable metering valve with flow meter

Product	Lubricant viscosity	Flow rate		Outlets	Operating pressure max.		Operating temperature		Page	
		mm <sup>2</sup> /s	l/min		pts/min	bar	psi	°C		°F
<b>SMD 1B (SKF VarioLub)</b>		50–650	0,05–1,0	0.1–2.1	2	16	230	0 to 70	32 to 158	54
<b>SMD 2 (SKF VarioLub)</b>		50–650	0,1–8,0	0.2–16.9	2	16	230	0 to 70	32 to 158	54
<b>SMD 3 (SKF VarioLub)</b>		50–650	4,0–40	8.5–85	1	16	230	0 to 70	32 to 158	54
<b>SF05A (SKF SafeFlow)</b>	1)	30–1 000	0,04–0,7 <sup>1)</sup>	0.08–1.5 <sup>1)</sup>	1, 2, 4, 6, 8, 10	15	215	max. 70	max. 158	56
<b>SF10A (SKF SafeFlow)</b>	1)	30–1 000	0,1–3,0 <sup>1)</sup>	0.2–6.3 <sup>1)</sup>	1, 2, 4, 6, 8, 10	15	215	max. 70	max. 158	56
<b>SF15A (SKF SafeFlow)</b>	1)	30–1 000	0,2–7,2 <sup>1)</sup>	0.4–15.2 <sup>1)</sup>	1, 2, 4, 6, 8, 10	15	215	max. 70	max. 158	56
<b>SF20A (SKF SafeFlow)</b>	1)	30–1 000	0,6–17 <sup>1)</sup>	1.3–35.9 <sup>1)</sup>	1, 2, 4, 6	15	215	max. 70	max. 158	56
<b>SF30A (SKF SafeFlow)</b>	1)	30–1 000	2,5–56 <sup>1)</sup>	5.3–118.3 <sup>1)</sup>	1	15	215	max. 70	max. 158	56
<b>FL15 (SKF Flowline Monitor)</b>		32–1 000	0,1–15	0.2–32	2, 4, 6, 8, 10	10	145	0 to +65	32 to 150	58
<b>FL50 (SKF Flowline Monitor)</b>		32–1 000	15–50	32.0–106	1	10	145	0 to +65	32 to 150	58
<b>FL100 (SKF Flowline Monitor)</b>		32–1 000	50–100	106–211	1	10	145	0 to +65	32 to 150	58

<sup>1)</sup> depending on the operating viscosity

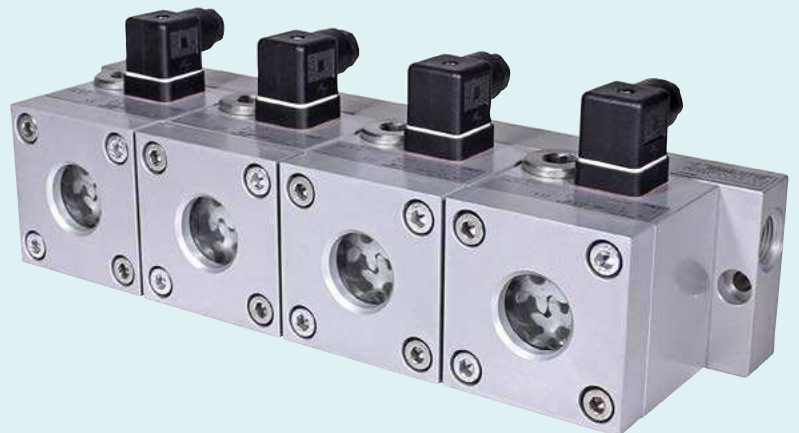
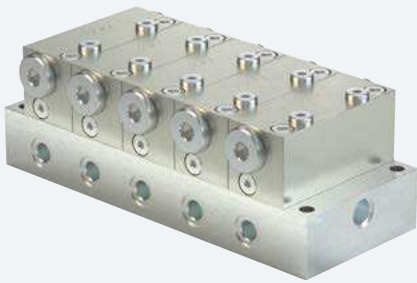

## Overview of oil circulation metering devices

### Pressure-compensated flow limiter with optional monitoring

Product	Lubricant viscosity	Flow rate		Outlets	Operating pressure		Operating temperature		Page
		mm <sup>2</sup> /s	l/min		pts/min	bar	psi	°C	
<b>SMB 3</b>	20–600	6,0–38	12.7–80	1	5–200	73–2 900	0 to 100	32 to 212	60
<b>SMB 6</b>	20–600	25–132	53–279	1	5–200	73–2 900	0 to 100	32 to 212	62
<b>SMB 8</b>	20–600	0,08–8	0.17–17	1–6	5–200	73–2 900	0 to 100	32 to 212	64
<b>SMB 9</b>	20–600	0,08–8	0.17–17	1–6	6–50	87–725	0 to 70	32 to 158	68
<b>SMB 10</b>	20–600	0.21–8.15	0.44–17.2	1–6	7–50	100–725	0 to 70	32 to 158	72
<b>SMB 13</b>	20–600	6,0–30	12.7–63.4	1	6–50	87–725	0 to 70	32 to 158	76
<b>SMB 14</b>	20–600	25–132	52.8–278.9	1	6–50	87–725	0 to 70	32 to 158	78

### Modular progressive metering device

Product	Lubricant viscosity	Flow rate		Outlets	Operating pressure max.		Operating temperature		Page
		mm <sup>2</sup> /s	l/min		pts/min	bar	psi	°C	
<b>PSG1</b>	> 12	0–0,8	0–1.7	6–20	200	2 900	-15 to +110	5 to 230	80
<b>PSG2</b>	> 12	0–2,5	0–5.3	6–20	200	2 900	-15 to +110	5 to 230	82
<b>PSG3</b>	> 12	0–6	0–12.7	6–20	200	2 900	-15 to +110	5 to 230	84
<b>VP</b>	> 12	0–1	0–2.1	6–20	200	2 900	-25 to +90	-13 to +194	86

## Screw-in restrictor

# VD



### Description

SKF screw-in flow restrictors VD are used to deliver relatively small amounts of oil to lubrication points. Four types of SKF VD are available, differing in tube diameter, flow rate and functionality. VD1 and VD4 restrictors can be combined and fit to manifolds, while VD2 and VD3 can be screwed directly into the ports of individual lubrication points. Screw-in restrictors VD3 and VD4 also come with a check valve to prevent leaks. These inexpensive flow restrictors are sensitive to dirt. Therefore, it is recommended to use a filter size of 10 µm.

### Features and benefits

- Easy planning and flow rate regulation
- Flow rate dependent on pressure and viscosity
- Check valve to prevent leaks (VD3, VD4)
- Fitting to manifolds and combination of screw-in restrictors possible (VD1, VD4)
- Direct threading into ports of individual lubrication points possible (VD2, VD3)

### Applications

- Machine tools
- Metal industry
- Presses
- Automation
- Industrial transmissions
- Automotive industry
- Heavy industry

### Technical data

Function	screw-in restrictor
Outlets	1
Lubricant	mineral and PAO oils; viscosity 10–1 000 mm <sup>2</sup> /s
Flow rate	0,001–0,23 l/min 0,002–0,49 pts/min
Operating temperature	0 to +60 °C; +32 to 140 °F
Operating pressure	10 bar; 145 psi
Filter	< 10 µm
Material	steel, brass
Main line connections:	
VD 1	M10×1
VD 2	M10×1 for tube Ø6 mm
VD 3	DIN 3862 fitting for tube Ø4 mm
VD 4	M8×1
Outlet connections:	
VD 1	M8×1 for tube Ø4 mm
VD 2	M10×1 (direct lub. point mounting)
VD 3	M10×1 tap (direct lub. point mounting)
VD 4	DIN 3862 fitting for tube Ø4 mm M8 or M10
Length:	
VD 1	30 mm; 1.18 in
VD 2	32 mm; 1.26 in
VD 3	32 mm; 1.26 in
VD 4	34 mm; 1.34 in
Mounting position	any



### NOTE

Further technical information, technical drawings, accessories, spare parts or product function descriptions available on [SKF.com/lubrication](http://SKF.com/lubrication):

**1-5006-EN**



3D

[skf-lubrication.partcommunity.com/3d-cad-models](http://skf-lubrication.partcommunity.com/3d-cad-models)



## Screw-in restrictor

# VD

Order number	Tube Ø mm	Flow rate 1)						Description 2)	Code
		at 2 bar		at 4 bar		at 6 bar			
		ml/min	pts/min	ml/min	pts/min	ml/min	pts/min		
<b>VD1-102</b>	4	1	0.0021	2,8	0.0059	4	0.0085	M10×1 for manifold mounting, washer <b>504-019</b>	2
<b>VD1-103</b>	4	2,8	0.0059	5,5	0.0116	8	0.0169	M10×1 for manifold mounting, washer <b>504-019</b>	3
<b>VD1-104</b>	4	5	0.0106	10	0.0211	15	0.0317	M10×1 for manifold mounting, washer <b>504-019</b>	4
<b>VD1-105</b>	4	7,5	0.0158	15	0.0317	23	0.0486	M10×1 for manifold mounting, washer <b>504-019</b>	5
<b>VD1-106</b>	4	15	0.0317	28	0.0592	40	0.0845	M10×1 for manifold mounting, washer <b>504-019</b>	6
<b>VD1-107</b>	4	35	0.0739	68	0.1437	100	0.2113	M10×1 for manifold mounting, washer <b>504-019</b>	7
<b>VD1-108</b>	4	58	0.1226	112	0.2367	170	0.3592	M10×1 for manifold mounting, washer <b>504-019</b>	8
<b>VD1-109</b>	4	77	0.1627	155	0.3276	230	0.4860	M10×1 for manifold mounting, washer <b>504-019</b>	9
<b>VD2-102</b>	6	1	0.0021	2,8	0.0059	4	0.0085	M10×1 for mounting direct into lubrication point	2
<b>VD2-103</b>	6	2,8	0.0059	5,5	0.0116	8	0.0169	M10×1 for mounting direct into lubrication point	3
<b>VD2-104</b>	6	5	0.0105	10	0.0211	15	0.0317	M10×1 for mounting direct into lubrication point	4
<b>VD2-105</b>	6	7,5	0.0159	15	0.0317	23	0.0486	M10×1 for mounting direct into lubrication point	5
<b>VD2-109</b>	6	77	0.1627	155	0.3276	230	0.4860	M10×1 for mounting direct into lubrication point	9
<b>VD3-099</b>	4	0,15	0.0003	0,28	0.0006	0,4	0.0008	M10×1 tab for mounting direct into lubrication point	00
<b>VD3-100</b>	4	0,3	0.0006	0,68	0.0014	1	0.0021	M10×1 tab for mounting direct into lubrication point	0
<b>VD3-101</b>	4	0,5	0.0011	1	0.0021	1,5	0.0032	M10×1 tab for mounting direct into lubrication point	1
<b>VD3-102</b>	4	1	0.0021	2	0.0042	3	0.0063	M10×1 tab for mounting direct into lubrication point	2
<b>VD4-099</b>	4	0,15	0.0003	0,28	0.0006	0,4	0.0008	M8×1 for manifold mounting, washer <b>DIN 7603-A8x11,5-CU</b>	00
<b>VD4-100</b>	4	0,3	0.0006	0,68	0.0014	1	0.0021	M8×1 for manifold mounting, washer <b>DIN 7603-A8x11,5-CU</b>	0

1) The shown flow rates are valid for an operating viscosity of 140 mm<sup>2</sup>/s. Flow rates change at the same time system pressure or lubricant viscosity change. Further details on request.  
2) Washer not included, but can be ordered separately

## Accessories - manifold

**Order code** V L -                

**Product series**                    

**Number of ports**  
**01** = 1 port    **03** = 3 ports    **05** = 5 ports    **08** = 8 ports  
**02** = 2 ports    **04** = 4 ports    **06** = 6 ports    **10** = 10 ports

**Design of outlet thread**  
**D** = Small profile, M8×1 with counterbore for flat washer (can only be selected for main line connection M3)  
**F** = Normal profile, M8×1 with counterbore for flat washer  
**G** = Normal profile, M10×1 with counterbore for flat washer

**Material**  
**A** = Aluminum;  
**E** = Stainless steel (only for outlet threads A, B, E, G)

**Design of main line connection**  
**G1** = G 1/8 to DIN 3852-2, Form X, small  
**G2** = G 1/4 to DIN 3852-2, Form X, small  
**M1** = M10×1 to DIN 3852-1, Form X, small  
**M2** = M14×1.5 to DIN 3852-1, Form X, small  
**M3** = M10×1 with counterbore for solderless pipe connection per DIN 3862  
**M4** = M14×1.5 with counterbore for solderless pipe connection per DIN 3862

**Order example**

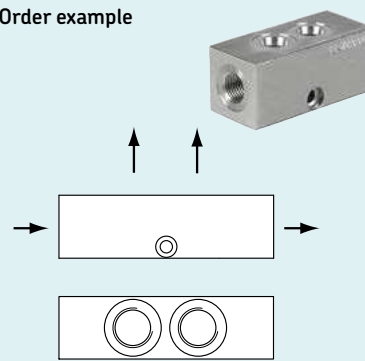

**VL-02FAM3**

- Product series VL
- 2 ports
- Normal profile made of aluminum
- M8×1 internal thread with counterbore for flat washer
- M10×1 main line connection with counterbore for solderless pipe connection per DIN 3862

## Flow divider

# SMT



### Description

The SKF flow divider SMT 1 splits the flow rate into two equal flows or into two individual flows at a specific ratio. Different defined dividing ratios are available from 1:1 to 1:4. Because the SMT 1 flow divider regulates itself, varying back pressures have negligible impact on the dividing accuracy. The SMT 1 is distinguished by its simple and compact design for installation near the lubrication point. Due to its corrosion-resistant material, it also can be utilized in aggressive environments. Additionally, this flow divider can be used with a wide range of viscosities from 50–1 300 mm<sup>2</sup>/s.

### Features and benefits

- Compact design for installation near lubrication point
- High accuracy due to self-regulating feature
- Corrosion resistant
- Easy flow adjustment (nozzle exchange)
- Inexpensive monitoring through upstream pressure switch or flow controller possible

### Applications

- Automotive
- Pulp and paper industry
- On-off road
- Machine tools
- Metal fabrication
- Power plants



### Technical data

Function	flow divider
Outlets	2
Operating temperature	0 to +100 °C; +32 to 212 °F
Operating pressure	100 bar; 1 450 psi
Lubricant	mineral and synthetic oils; viscosity 50–1 300 mm <sup>2</sup> /s
Flow rate	0,5–6,0 l/min 1,05–12,7 pts/min
Dividing ratios	1:1; 1:1,5; 1:2; 1:2,5; 1:3; 1:3,5; 1:4
Dividing accuracy	≥ 95 %
Material	aluminium, anodized
Dimensions	30 × 69 × 58 mm 1,18 × 2,72 × 2,28 in
with inline strainer	87 × 69 × 108 mm 3,43 × 2,72 × 4,25 in
Mounting position	any



### NOTE

Further technical information, technical drawings, accessories, spare parts or product function descriptions available on [SKF.com/lubrication](http://SKF.com/lubrication):

**1-5017-EN; 1-5006-EN**

# Flow divider

## SMT

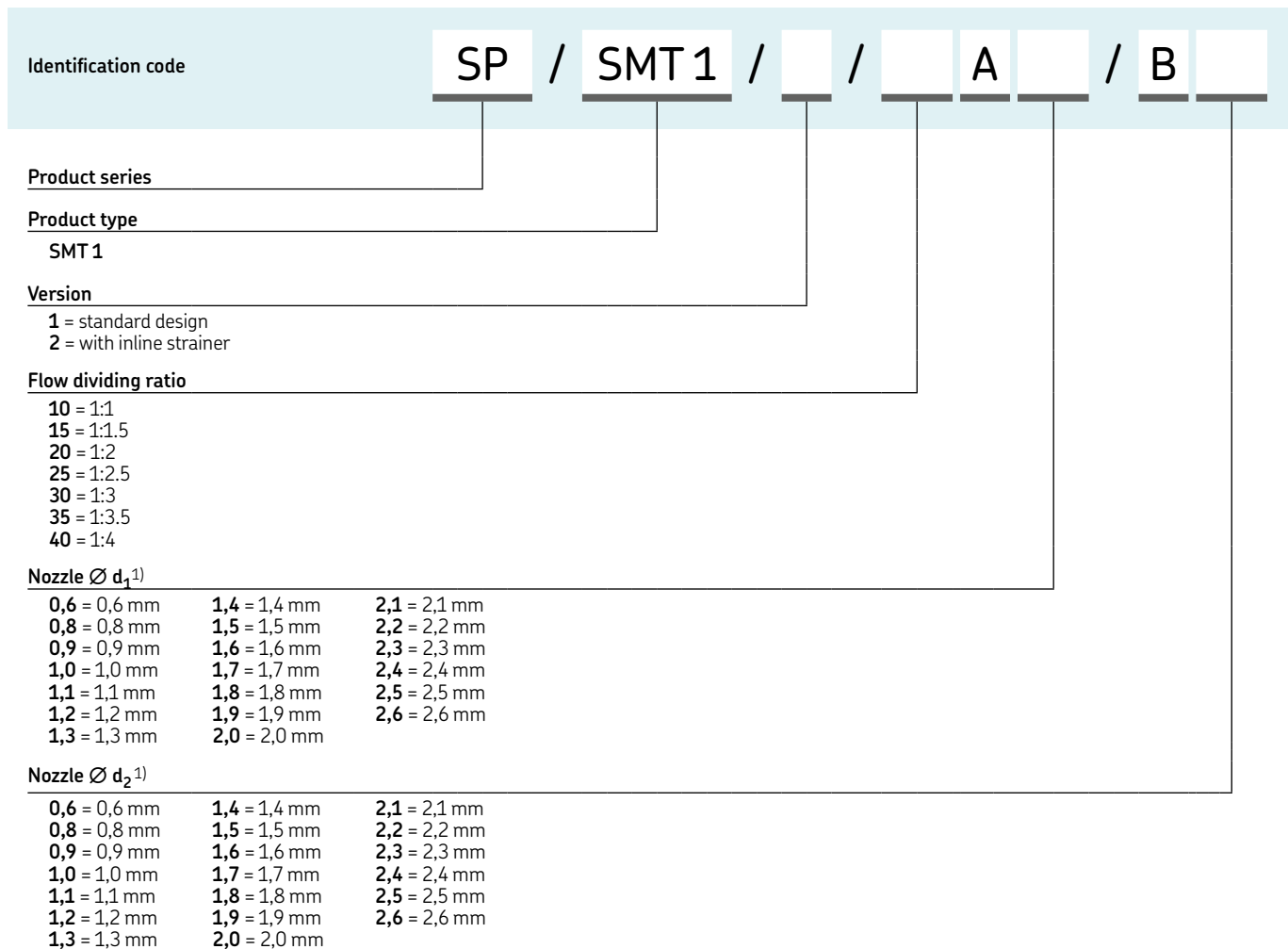

<sup>1)</sup> Nozzle diameters d<sub>1</sub> and d<sub>2</sub> need to be determined using a diagram, see brochure 1-5017. Identification code positions A and B are three-digit numbers representing the nozzle sizes. The code for the example would be: d<sub>1</sub> (0.9 mm) = 090 and for d<sub>2</sub> (1.4 mm) = 140

# Adjustable restrictor

# 242



## Description

The SKF adjustable restrictors 242 are used if a subsequent adjustment of the flow rate is required. The restrictors come in three versions, differing in metering quantity, visual flow indication and number of outlets. Type A flow rates are within the drop-feed range of 0 to 0,01 l/min (0 to 0.02 pts). The adjustable restrictor 242 offers 1 to 14 outlets and a sight-glass for flow rate monitoring. Type B offers continuous metering quantity from 0,01 to 1,0 l/min (0.02 to 2.11 pts) and comes with 2 to 12 outlets. Type C metering quantity ranges from 0,01 to 2,0 l/min (0.02 to 4.23 pts). Depending on the distributor, 2 to 6 outlets are available. Types B and C offer a spring-loaded metal pin in the sight-glass for visual oil flow monitoring.

## Features and benefits

- Easy adjustable
- Easy planning and quantity regulation
- Cost-effective visual oil flow monitoring
- Individual regulation of flow range for each lubrication point
- Wide viscosity range

## Applications

- Oil and Gas
- Machine tools
- Metal fabrication
- Metal forming
- Textiles

## Technical data

Function	adjustable restrictor
Lubricant	mineral and synthetic oils; viscosity 10–1 000 mm <sup>2</sup> /s
Outlets:	
A	1, 2, 5, 14
B	2, 3, 4, 5, 6, 10, 12
C	2 to 6
Metering quantity:	
A	0 to 0.01 l/min; 0 to 0.02 pts/min
B	0.01 to 1.0 l/min; 0.02 to 2.11 pts/min
C	0.01 to 2.0 l/min; 0.02 to 4.23 pts/min
Operating temperature	0 to +60 °C; +32 to 140 °F
Operating pressure	max. 10 bar max. 145 psi
Filter	< 10 µm
Material	steel
Connection:	
A + B	M10×1 for tube 6 mm
C	M16×1,5 for tube 10 mm
Dimension:	
depending on model	min. 93 × 16 × 32 mm max. 97 × 25 × 253 mm min. 3.66 × 0.63 × 1.29 in max. 3.82 × 0.98 × 9.96 in
Mounting position:	any

## NOTE

Further technical information, technical drawings, accessories, spare parts or product function descriptions available on [SKF.com/lubrication](http://SKF.com/lubrication):

**1-5006-EN**



3D

[skf-lubrication.partcommunity.com/3d-cad-models](http://skf-lubrication.partcommunity.com/3d-cad-models)



## Adjustable restrictor

# 242



### 242 Type A

Metering quantity: 0–10 cm<sup>3</sup>; 0–0.6 in<sup>3</sup>

Order number	Outlets
242-016.00	1
242-026.00	2
242-056.00	5
242-146.00	14

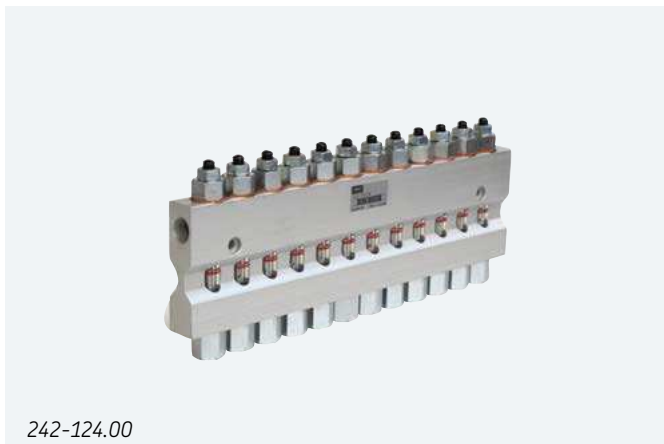

### 242 Type B

Metering quantity: 10–1 000 cm<sup>3</sup>; 0.6–61 in<sup>3</sup>

Order number	Outlets
242-024.00	2
242-034.00	3
242-044.00	4
242-054.00	5
242-064.00	6
242-104.00	10
242-124.00	12

Indicating at 110 mm<sup>2</sup>/s; start at 10, end at 1 000 or 2 000 cm<sup>3</sup>/min



### 242 Type C

Metering quantity: 10–2 000 cm<sup>3</sup>; 0.6–122 in<sup>3</sup>

Order number	Outlets
242-025.00	2
242-035.00	3
242-045.00	4
242-055.00	5
242-065.00	6

Indicating at 110 mm<sup>2</sup>/s; start at 10, end at 1 000 or 2 000 cm<sup>3</sup>/min

## Accessories

### 242 Type A and B, main tube connector and accessories

Order number	Designation	Tube
		Ø mm
406-162	main tube connector	6
408-162	main tube connector	8
410-162	main tube connector	10
408-211	screw plug	–
508-215-CU	washer	–

### 242 Type C, main tube connector and accessories

Order number	Designation	Tube
		Ø mm
410-018	main tube connector	10
412-018	main tube connector	12
412-011	screw plug	–
DIN7603-A18x22-CU	washer	–

## Flow meter

# SKF VarioLub



### Description

SKF VarioLub SMD flow meters are designed to meter and monitor the flow in oil circulation lubrication systems. They are offered in three different versions covering a flow rate of 0,05 to 40 l/min. The flow meters can be adjusted by a built-in adjustment valve. The meters provide visual and electronic monitoring, and the by-pass system allows adjustment and service, even while the system is running. Due to their modular design, SMD flow meters can be easily replaced, adapted and expanded. They are suitable for machines with several hundred lubrication points and provide reliability and flexibility.

### Features and benefits

- High accuracy and robust design
- Easy maintenance and reduced downtime due to bypass system
- Modular system enables flow rate changes and system extension
- Many industry interfaces available
- Monitoring by SKF IPM12 pulse meter
- Programming and set up by SKF PGA3 or SKF VarioLub software

### Applications

- Pulp and paper industry
- Machine tools
- Metal industry
- Heavy industry

### Technical data

Function	gear wheel flow meter
Outlets	SMD 1B, SMD 2: 2 SMD 3: 1
Lubricant	mineral and synthetic oils; viscosity 50–650 mm <sup>2</sup> /s
Flow rate	
SMD 1B:	0,05–1,0 l/min; 0.1–2.1 pts/min
SMD 2:	0,1–8,0 l/min; 0.2–16.9 pts/min
SMD 3:	4,0–40,0 l/min; 8.5–84.5 pts/min
Operating temperature	0 to +70 °C +32 to 158 °F
Operating pressure	16 bar 232 psi
Material	housing: anodized aluminium lid: PMMA gear wheels: GPR SMD3 :GPR / aluminum
Inlet connection	G 3/4 BSPP; G 1 1/16-12 UN
Outlet connection	
SMD 1B, SMD2:	G 3/8 BSPP; G 9/16-18 UN
SMD3:	G 3/4 BSPP; G 1 1/16-12 UN
Protection class	IP 65
Dimensions	
SMD 1B/SMD 2	90 × 70 × 150 mm 3.54 × 2.7 × 5.91 in
SMD 3	110 × 130 × 150 mm 4.33 × 5.1 × 5.91 in
Mounting position	any
Options	connection block, shut-off block, flushing port



### NOTE

Further technical information, technical drawings, accessories, spare parts or product function descriptions available on [SKF.com/lubrication](http://SKF.com/lubrication):

**1-3021-EN**

## Flow meter

# SKF VarioLub

### Variolub SMD

Type	Designation	Outlets	Flow rate		Order number	
			l/min	pts/min	Connection thread BSPP	UN / UNF
<b>SMD 1B</b>	2 very fine adjustment valves	2	2 × 0,05–1,0	2 × 0.1–2.1	<b>24-2581-2650</b>	<b>24-2581-2651</b>
<b>SMD 2</b>	2 fine adjustment valves	2	2 × 0,1–4,4	2 × 0.2–9.3	<b>24-2581-2656</b>	<b>24-2581-2615</b>
<b>SMD 2</b>	2 coarse adjustment valves	2	2 × 4,0–8,0	2 × 8.5–16.9	<b>24-2581-2657</b>	<b>24-2581-2617</b>
<b>SMD 2</b>	1 fine adjustment valve (top) 1 coarse adjustment valve (down)	2	1 × 0,1–4,4 1 × 4,0–8,0	1 × 0.2–9.3 1 × 8.5–16.9	<b>24-2581-2658</b>	<b>24-2581-2616</b>
<b>SMD 3</b>	1 very coarse adjustment valve	1	1 × 4,0–40	1 × 8.5–84.5	<b>24-2581-2652</b>	<b>24-2581-2693</b>

### Variolub SMD bank mounting components

Type	Designation	Order number	
		Connection thread BSPP	UN / UNF
<b>SMD 1B/SMD 2</b>	connection block complete	<b>24-1503-2103</b>	<b>24-1503-2104</b>
<b>SMD 1B/SMD 2</b>	shut-off block complete	<b>24-1503-2102</b>	on request
<b>SMD 1B/2/3</b>	plug screws G 3/4 BSPP; DIN 908 1.1/16-12 UN	<b>95-0034-0908</b>	–
<b>SMD 1B/2/3</b>	seal A27 × 32 DIN 7603 Cu	<b>95-2721-7603</b>	–

### Variolub SMD Accessories

Type	Designation	Order number	
		Connection thread BSPP	UN / UNF
<b>SMD 1B</b>	spare part kit	<b>24-9909-0184</b>	<b>24-9909-0184</b>
<b>SMD 2</b>	spare part kit	<b>24-9909-0178</b>	<b>24-9909-0178</b>
<b>SMD 3</b>	spare part kit	<b>24-9909-0179</b>	<b>24-9909-0179</b>
<b>SMD 1B/SMD 2</b>	seal kit	<b>24-0404-2520</b>	<b>24-0404-2520</b>
<b>SMD 3</b>	seal kit	<b>24-0404-2521</b>	<b>24-0404-2521</b>
<b>SMD 1B/SMD 2</b>	mounting screw 4 × <sup>1)</sup>	<b>DIN912-M6×60-8.8D2R</b>	<b>DIN912-M6×60-8.8D2R</b>
<b>SMD 3</b>	mounting screw 4 × <sup>1)</sup>	<b>DIN912-M6×45-8.8D2R</b>	<b>DIN912-M6×45-8.8D2R</b>

<sup>1)</sup> Mounting screw is included in delivery of SMD 1B and SMD 2

## Flow meter

# SKF Safeflow



### Description

SKF Safeflow flow meters control and indicate the flow rate in oil circulation lubrication systems. Each flow meter can be calibrated individually according to oil viscosity and desired flow. SKF Safeflow covers a flow rate of 0,04 to 56 l/min (0.08–118 pts/min) per lubrication point and can be banked (up to 10 units wide) to reduce piping and simplify installation. These flow meters offer excellent readability and visual monitoring due to their operating principle of straight glass flow tubes with internal calibration cones.

### Features and benefits

- Easy and individual calibration of flow meters with adjustable flow rate
- SF05A, SF10A and SF15A can be combined in same module
- Common or individual electronic alarms available

### Applications

- Pulp and paper industry
- Metal industry
- Power plants
- Mining

### Technical data

Function	variable area flow meter
Lubricant	mineral and synthetic oils; viscosity 30–1 000 mm <sup>2</sup> /s
Flow rate	0,04–56 l/min; 0.08–118 pts/min
Operating temperature	0 to +70 °C; +32 to 158 °F
Operating pressure	15 bar; 217 psi
Outlets	1–10
Material	aluminum, glass
Electrical alarm:	
Power supply	24V DC (22–36 V DC) or 24V AC (18–27 V AC RMS)
Power consumption	max. 150 mA
Alarm output	dry contact relay output max. load 50 VAC/DC, 1A
Protection class	IP65
Dimensions:	
SF05A/10A/15A	min. 170 × 97 × 170 mm max. 170 × 97 × 566 mm min. 6.69 × 3.82 × 6.69 in max. 6.69 × 3.82 × 22.28 in
SF20	min. 250 × 94 × 74 mm max. 250 × 94 × 324 mm min. 9.84 × 3.70 × 2.91 in max. 9.84 × 3.70 × 13.46 in
SF30	275 × 100 × 129 mm 10.83 × 3.94 × 5.08 in
Mounting position	horizontal

### NOTE

Further technical information, technical drawings, accessories, spare parts or product function descriptions available on [SKF.com/lubrication](http://SKF.com/lubrication): **6409/2**



3D

[skf-lubrication.partcommunity.com/3d-cad-models](http://skf-lubrication.partcommunity.com/3d-cad-models)



## Flow meter

# SKF Safeflow

<b>Identification code</b>	<table border="1" style="margin: auto;"> <tr> <td style="padding: 5px;">SF</td> <td style="width: 20px;"></td> <td style="padding: 5px;">A</td> <td style="width: 20px;"></td> <td style="width: 20px;"></td> <td style="width: 20px;"></td> <td style="width: 20px;"></td> <td style="width: 20px;"></td> </tr> </table>	SF		A					
SF		A							
<b>Product types</b>									
SF = Safeflow									
<b>Flow rate per flow meter</b>									
05 = 100 mm <sup>2</sup> /s: 0,1–0,7 l/min; 0.2–1.5 pts/min 220 mm <sup>2</sup> /s: 0,04–0,35 l/min; 0.08–0.74 pts/min									
10 = 100 mm <sup>2</sup> /s: 0,1–3,0 l/min; 0.2–6.3 pts/min 220 mm <sup>2</sup> /s: 0,1–1,7 l/min; 0.08–0.74 pts/min									
15 = 100 mm <sup>2</sup> /s: 0,3–7,2 l/min; 0.6–15.2 pts/min 220 mm <sup>2</sup> /s: 0,2–4,4 l/min; 0.4–9.3 pts/min									
20 = 100 mm <sup>2</sup> /s: 1,3–17,0 l/min; 2.7–35.9 pts/min 220 mm <sup>2</sup> /s: 0,6–10,6 l/min; 5.3–93.0 pts/min									
30 = 100 mm <sup>2</sup> /s: 5,0–56,0 l/min; 10.6–118.3 pts/min 220 mm <sup>2</sup> /s: 2,5–44,0 l/min; 5.3–93.0 pts/min									
<b>Calibration cone</b>									
A = adjustable cone									
<b>Outlets</b>									
1 = 1, SF05A–SF30A 2 = 2, SF05A–SF20A 4 = 4, SF05A–SF20A	6 = 6, SF05A–SF20A 8 = 8, SF05A–SF15A 10 = 10, SF05A–SF15A								
<b>Connection ports</b>									
R = BSPP U = NPT									
<b>Alarm electrical</b> (Alarm units for SF20A and SF30A must be ordered separately)									
X = no alarm A = with electrical alarm									
<b>Alarm type</b>									
BSC = common alarm BSS = individual alarm									

### Alarm units for Safeflow SF20A and SF30A<sup>1)</sup>

Order number	Designation
BSC-12030	common alarm
BSS-12030	individual alarm

<sup>1)</sup> Must be ordered separately



BSC-12030

### Safeflow connections

Products	Outlets	Connection inlet		Outlet connection
		group size 1	group size 2-10	
		BSPP / NPT	BSPP / NPT	BSPP / NPT
SF05A	1, 2, 4, 6, 8, 10	1/2	1	1/2
SF10A	1, 2, 4, 6, 8, 10	1/2	1	1/2
SF15A	1, 2, 4, 6, 8, 10	1/2	1	1/2
SF20A	1, 2, 4, 6	1/2	1	3/4
SF30A	1	1 1/4	1	1 1/4

## Flow meter

# SKF Flowline Monitor



### Description

The SKF Flowline Monitor is used to divide, measure and control the flow rate in oil circulation lubrication systems. Three different flow meter sizes enable control and monitoring of 0,1 to 100 l/min flows with operating viscosities from 32 to 1 000 mm<sup>2</sup>/s. The flow meters operate individually and can be programmed and adjusted separately. Regardless of oil temperature and viscosity changes, the SKF Flowline Monitor provides accurate results. Computer configuration and remote monitoring are possible. Monitoring modules are available offering common alarms, individual alarms for each lubrication point and interfaces to process controls.

### Features and benefits

- Minimal pressure loss due to turbine-based monitoring and adjusting-valve technology
- Easy-to-use interface
- Indication of flow accuracy of each lubrication point
- Modular monitoring capabilities
- Panel mounting possible

### Applications

- Pulp and paper industry
- Metal industry
- Mining
- Power plants
- Other industries and applications

### Technical data

Function	turbine flow meter
Lubricant	mineral, synthetic or environmentally friendly oils with a viscosity of 32–1 000 mm <sup>2</sup> /s
Flow meters:	
FL15	2, 4, 6, 8, 10
FL50, FL 100	1
Flow rate:	
FL15	0,1–15 l/min; 0,2–32 pts/min
FL50	15–50 l/min; 32–105 pts/min
FL100	50–100 l/min; 105–210 pts/min
Operating temperature	0 to + 65 °C; + 32 to 150 °F
Operating pressure	max. 10 bar; 145 psi
Power supply	20–36 V DC 24 V AC (-20 to + 5%)
Power consumption	5 W
Alarm relay	potential free contact; max. load 30 V DC / 1 A, 120 V AC / 1 A, resistive load
Inlet connection	
depending on model	G / NPT 1; G / NPT 2x1
Outlet connection	G / NPT 1/2; G / NPT 1 1/4
Protection class	IP 65
Dimensions	min. 150 × 106 × 226 mm max. 150 × 230 × 618 mm min. 5.9 × 4.17 × 8.9 in max. 5.9 × 9.05 × 24.33 in



### NOTE

Further technical information, technical drawings, accessories, spare parts or product function descriptions available on [SKF.com/lubrication](http://SKF.com/lubrication):

**17075 EN**



3D

[skf-lubrication.partcommunity.com/3d-cad-models](http://skf-lubrication.partcommunity.com/3d-cad-models)

# SKF Flowline Monitor

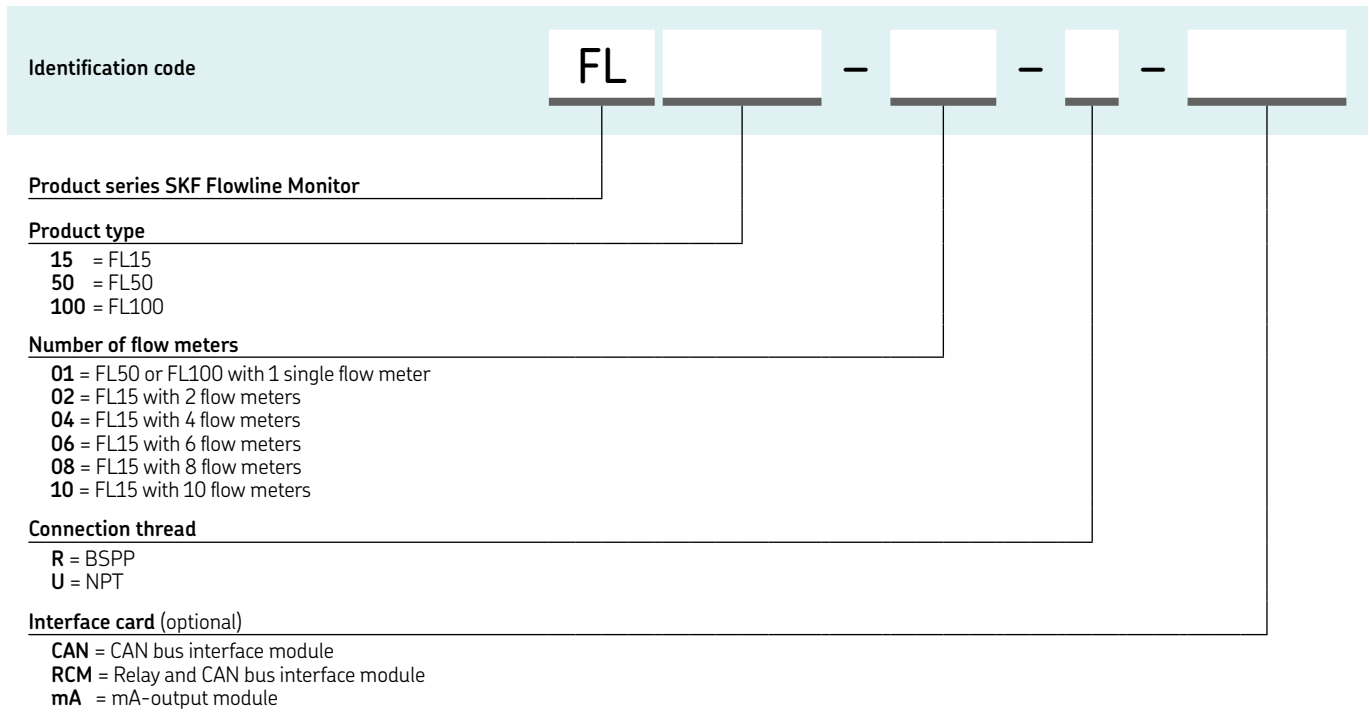

Order numbers		Order numbers		Order numbers	
Order number	Flow meter type	Order number	Flow meter type	Order number	Flow meter type
<b>FL with BSPP connection thread (R)</b>		<b>FL with NPT connection thread (U)</b>		<b>FL with mA module</b>	
13120202	FL15-02-R	13120222	FL15-02-U	13120362	FL15-02-R-mA
13120204	FL15-04-R	13120224	FL15-04-U	13120364	FL15-04-R-mA
13120206	FL15-06-R	13120226	FL15-06-U	13120366	FL15-06-R-mA
13120208	FL15-08-R	13120228	FL15-08-U	13120368	FL15-08-R-mA
13120210	FL15-10-R	13120230	FL15-10-U	13120370	FL15-10-R-mA
13120300	FL50-R	13120320	FL50-U	13120372	FL15-02-U-mA
13127800	FL100-01-R	13127810	FL100-01-U	13120374	FL15-04-U-mA
13120180	connection block G 1 1/4	13120182	connection block NTP 1 1/4	13120376	FL15-06-U-mA
<b>FL with CAN module</b>		<b>FL with relay and CAN module</b>		13120378	FL15-08-U-mA
13120212	FL15-02-R-CAN	13120342	FL15-02-R-RCM	13120380	FL15-10-U-mA
13120214	FL15-04-R-CAN	13120344	FL15-04-R-RCM	13120314	FL50-R-mA
13120216	FL15-06-R-CAN	13120346	FL15-06-R-RCM	13120334	FL50-U-mA
13120218	FL15-08-R-CAN	13120348	FL15-08-R-RCM	13127804	FL100-01-R-mA
13120220	FL15-10-R-CAN	13120350	FL15-10-R-RCM	13127816	FL100-01-U-mA
13120232	FL15-02-U-CAN	13120352	FL15-02-U-RCM		
13120234	FL15-04-U-CAN	13120354	FL15-04-U-RCM		
13120236	FL15-06-U-CAN	13120356	FL15-06-U-RCM		
13120238	FL15-08-U-CAN	13120358	FL15-08-U-RCM		
13120240	FL15-10-U-CAN	13120360	FL15-10-U-RCM		
13120310	FL50-R-CAN	13120312	FL50-R-RCM		
13120330	FL50-U-CAN	13120331	FL50-U-RCM		
13127808	FL100-01-R-CAN	13127802	FL100-01-R-RCM		
13127818	FL100-01-U-CAN	13127812	FL100-01-U-RCM		

## Flow limiter

## SMB 3



## Description

The SKF SMB 3 flow limiter is designed to divide the main line flow into parallel, individual flows. The flow is generated independently of system pressure changes and virtually independently of viscosity, guaranteeing a constant flow. The SMB 3 provides a flow rate from 6 to 38 l/min (12.6–80.3 pts/min) and a pressure range of up to 200 bar. The flow limiter offers oil flow monitoring with a signal transmitter or piston detector. These indicators create a fault signal when the flow rate drops to approximately 85%.

## Features and benefits

- Stable system regardless of pressure, temperature or viscosity changes
- Easy start-up with fixed flow rate via pre-selected nozzle sizes
- Adaptation of flow rate possible (nozzle exchange)
- High operating temperature up to +100 °C
- Optional ATEX version Ex II 3 cII CT6

## Applications

- Oil and Gas
- Machine tools
- Metal forming
- Industrial transmissions

## Technical data

Function	flow limiter
Outlets	1
Lubricant	environmentally friendly mineral and synthetic oils; viscosity 20–600 mm <sup>2</sup> /s
Flow rate <sup>1)</sup>	6–38 l/min; 12.6–80.3 pts/min
Operating temperature	0 to +100 °C; +32 to 212 °F
Operating pressure <sup>2)</sup>	5–200 bar 72–2 900 psi
Differential pressure	>5 bar >72 psi
Material	gray cast iron, zinc coated
Connection	M12×1; 4-poles coupler socket
Protection class	IP 65
Signal sensors E4/E5	24 V to 230 V AC/DC
Proximity switch E6	12 to 36 VDC; IP 67
Dimensions	min. 40 × 90 × 138 mm max. 40 × 90 × 245 mm min. 1.57 × 3.54 × 5.43 in max. 1.57 × 3.54 × 9.63 in
Mounting position	any, preferably vertical

<sup>1)</sup> For technical reasons oil output of the system's feeding pump must be > 10–15% of all flow limiters flow rates mounted in the system.

<sup>2)</sup> See further details under monitoring SMB3/6/8

**NOTE**

Further technical information, technical drawings, accessories, spare parts or product function descriptions available on [SKF.com/lubrication](http://SKF.com/lubrication):

**1-3001-EN**



## Flow limiter

# SMB 3

Identification code	24	-	27	03	-		-	
Product series	SMB							
Product type	03 = SMB 3							
Type of monitoring	0 = without monitoring 6 = with piston detector E6 7 = with signal transmitter E4 8 = with signal transmitter E5							
Flow rate	Plug-in nozzle size = see table below							
ATEX	ATEX = on request, only for ATEX (EX II 3cII CT6), without monitoring or with signal transmitter E5							

### SMB 3 plug-in nozzle

Order number	Flow rate <sup>1)</sup>		Nozzle Ø mm	Order number	Flow rate <sup>1)</sup>		Nozzle Ø mm
	l/min	pts/min			l/min	pts/min	
250	6,00	12.6	2,50	430	16,00	33.8	4,30
260	6,50	13.7	2,60	440	16,75	35.4	4,40
270	6,75	14.2	2,70	450	17,50	36.9	4,50
280	7,00	14.8	2,80	460	18,00	38.0	4,60
290	7,50	15.9	2,90	470	18,75	39.6	4,70
300	8,00	16.9	3,00	480	19,50	41.2	4,80
310	8,75	18.5	3,10	490	20,25	42.8	4,90
320	9,25	19.5	3,20	500	21,00	44.3	5,00
330	9,75	20.6	3,30	510	21,75	45.9	5,10
340	10,50	22.1	3,40	520	22,50	47.5	5,20
350	11,00	23.2	3,50	530	23,25	49.1	5,30
360	11,50	24.3	3,60	540	24,00	50.7	5,40
370	12,00	25.3	3,70	550	25,00	52.8	5,50
380	12,75	26.9	3,80	570	26,50	56.0	5,70
390	13,50	28.5	3,90	580	28,00	59.1	5,80
400	14,00	29.5	4,00	600	30,00	63.4	6,00
410	14,75	31.1	4,10	650	34,00	71.8	6,50
420	15,50	32.7	4,20	690	38,00	80.3	6,90

<sup>1)</sup> at an operating viscosity of 300 mm<sup>2</sup>/s

### SMB 3 accessories

Order number	Designation	Order number	Designation
24-0404-2119	<b>Seal kit</b>	24-1884-2282	<b>E6 piston detector</b>
24-1072-2113	<b>E4 signal transmitter</b>	179-990-371	piston detector
24-1072-2115	signal transmitter without coupler socket	179-990-372	socket straight, 4-pole, M12×1
	signal transmitter with coupler socket	179-990-600	socket angled, 4-pole, M12×1
	with LED 24 V DC		socket straight, 4-pole,
24-1882-2151	coupler socket with LED 24 V DC	179-990-601	M12×1 with orange cable, 5 m
	<b>E5 signal transmitter</b>		socket angled, 4-pole,
24-1072-2113	signal transmitter without coupler socket		M12×1 with orange cable, 5 m
24-1072-2114	signal transmitter with coupler socket	84-8011-0369	<b>Monitoring</b>
	without LED 230 V AC/DC	24-1883-2081	group monitoring unit
24-1882-2121	coupler socket without LEDs		<b>Flow limiter</b>
			without nozzle, without signal transmitter

For further information on monitoring extensions, see IPM 12

## Flow limiter

## SMB 6



## Description

The SMB 6 flow limiter is designed to divide the main line flow into parallel, individual, flows. The flow is generated independently of system pressure changes and virtually independently of viscosity, guaranteeing a constant flow. The SMB 6 provides a flow rate from 25 to 132 l/min (52.8–279 pts/min) and a pressure range of up to 200 bar (2 900 psi). The flow limiter offers oil flow monitoring with a signal transmitter or piston detector. These indicators create a fault signal when the flow rate drops to approximately 85%.

## Features and benefits

- Stable system regardless of pressure, temperature or viscosity changes
- Easy start-up with fixed flow rate via pre-selected nozzle sizes
- Adaptation of flow rate possible (nozzle exchange)
- High operating temperature up to +100 °C
- Optional ATEX version Ex II 3 cII CT6

## Applications

- Metal forming
- Pulp and paper industry
- Automotive
- Presses
- Heavy industry

## Technical data

Function	flow limiter
Outlets	1
Lubricant	environmentally friendly, mineral and synthetic oils; viscosity 20–600 mm <sup>2</sup> /s
Flow rate <sup>1)</sup>	25–132 l/min 52.8–279 pts/min
Operating temperature	0 to +100 °C; +32 to 212 °F
Operating pressure <sup>2)</sup>	5–200 bar 72–2 900 psi
Differential pressure	>5 bar >72 psi
Material	gray cast iron, zinc coated
Connection	M12×1; 4-poles coupler socket
Protection class	IP 65
Signal sensors E4/E5	24 V to 230 V AC/DC; IP 65
Proximity switch E6	12 to 36 VDC; IP 67
Dimensions	min. 40 × 90 × 138 mm max. 40 × 90 × 245 mm min. 1.57 × 3.54 × 5.43 in max. 1.57 × 3.54 × 9.63 in
Mounting position	any, preferably vertical

- <sup>1)</sup> For technical reasons oil output of the system's feeding pump must be > 10–15% of all flow limiters flow rates mounted in the system. Higher metering quantities available on request  
<sup>2)</sup> See further details under monitoring SMB3/6/8



## NOTE

Further technical information, technical drawings, accessories, spare parts or product function descriptions available on [SKF.com/lubrication](http://SKF.com/lubrication):

**1-3001-EN**

## Flow limiter

# SMB 6

Identification code	24	-	27	06	-		-	
Product series	SP/SMB		06 = SP/SMB 6					
Product type	06 = SP/SMB 6							
Type of monitoring	0 = without monitoring 6 = with piston detector E6		7 = with signal transmitter E4 8 = with signal transmitter E5					
Flow rate	Plug-in nozzle size = see table below							
ATEX	ATEX = on request, only for ATEX (EX II 3cll CT6), without monitoring or with signal transmitter E5							

### SMB 6 plug-in nozzle

Order number	Flow rate <sup>1)</sup>		Nozzle	Order number	Flow rate <sup>1)</sup>		Nozzle
	l/min	pts/min	Ø mm		l/min	pts/min	Ø mm
570	25	52.8	5,70	000	70	147.9	10,00
630	30	63.4	6,30	040	75	158.5	10,40
680	35	73.9	6,80	080	80	169.0	10,80
730	40	84.5	7,30	170	90	190.2	11,70
780	45	95.1	7,80	270	100	211.3	12,70
820	50	105.7	8,20	310	105	221.9	13,10
870	55	116.2	8,70	350	110	232.5	13,50
910	60	126.8	9,10	400	116	245.1	14,00
960	65	137.4	9,60	440	120	253.6	14,40
				530	132	278.9	15,30

<sup>1)</sup> at an operating viscosity of 300 mm<sup>2</sup>/s

## Accessories

### SMB 6 accessories

Order number	Designation	Order number	Designation
24-0712-6050	<b>Flow limiter</b> without nozzle, without signal transmitter	24-1072-2113 24-1072-2114	<b>E5 signal transmitter</b> signal transmitter without coupler socket signal transmitter with coupler socket without LED 230 V AC/DC coupler socket without LEDs
24-0404-2155	<b>Seal kit</b>	24-1882-2121	<b>E6 piston detector</b> piston detector socket straight, 4-pole, M12×1 socket angled, 4-pole, M12×1 socket straight, 4-pole, M12×1 with orange cable, 5 m socket angled, 4-pole, M12×1 with orange cable, 5 m
84-8011-0369	<b>Monitoring</b> group monitoring unit	24-1884-2282 179-990-371 179-990-372 179-990-600 179-990-601	
24-1072-2113 24-1072-2115	<b>E4 signal transmitter</b> signal transmitter without coupler socket signal transmitter with coupler socket with LED 24 V DC		
24-1882-2151	coupler socket with LED 24 V DC		

For further information for monitoring extensions IPM 12

## Flow limiter

# SMB 8



### Description

The SMB 8 flow limiter is designed to divide the main line flow into parallel, individual flows. The flow is generated independently of system pressure changes and virtually independently of viscosity, guaranteeing a constant flow. The SMB 8 provides a flow rate from 0,08 to 8 l/min (0.16–16.9 pts/min) and a pressure range of up to 200 bar (2 900 psi). The flow limiter offers oil flow monitoring with a signal transmitter or piston detector. These indicators create a fault signal when the flow rate drops to approximately 70%. Up to six SMB 8 can be combined on a mounting plate, providing a simple, space-saving installation and compact construction with only one inlet.

### Features and benefits

- Stable system regardless of pressure, temperature or viscosity changes
- Easy start-up with fixed flow rate via pre-selected nozzle sizes
- Adaptation of flow rate possible (nozzle exchange)
- Optional ATEX version Ex II 3 dII CT6
- Available as attachment to PSG2, PSG3 and VP on the same mounting plate

### Applications

- Metal forming and presses
- Heavy industry
- Pulp and paper industry
- Industrial transmissions
- Automation

### Technical data

Function	2-way flow limiter	
Outlets	1–6 on mounting plate	
Lubricant	environmentally friendly mineral and synthetic oils; viscosity 20–600 mm <sup>2</sup> /s	
Flow rate <sup>1)</sup>	0,08–8 l/min;	0.16–16.9 pts/min
Operating temperature	0 to +100 °C	+32 to 212 °F
Operating pressure <sup>2)</sup>	5–200 bar	72–2 900 psi
Differential pressure	>5 bar	>72 psi
Material	AlCuPb F38, neutrally anodized	
Connection	M12×1; 4-poles coupler socket	
Protection class	IP 65	
Signal sensors E4/E5	24 V to 230 V AC/DC; IP 65	
Proximity switch E6	12 to 36 VDC; IP 67	
Dimensions	min. 40 × 45 × 78,5 mm max. 40 × 45 × 185 mm min. 1.57 × 1.77 × 3.09 in max. 1.57 × 1.77 × 7.28 in	
Mounting position	any, filter always in upright position	

<sup>1)</sup> For technical reasons oil output of the system's feeding pump must be > 10–15% of all flow limiters flow rates mounted in the system.  
<sup>2)</sup> See further details under monitoring SMB3/6/8

### NOTE

Further technical information, technical drawings, accessories, spare parts or product function descriptions available on [SKF.com/lubrication](http://SKF.com/lubrication):  
**1-3028-EN**



## Flow limiter

# SMB 8

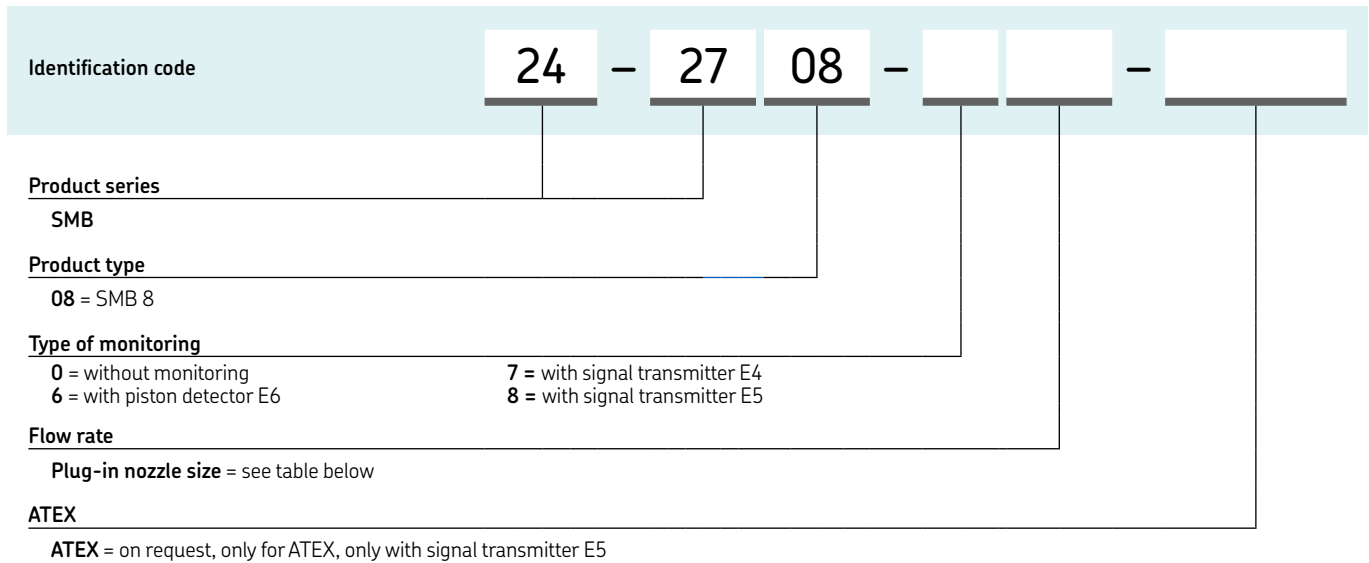

### SMB 8 plug-in nozzle

Order number	Flow rate <sup>1)</sup>		Nozzle Ø mm	Order number	Flow rate <sup>1)</sup>		Nozzle Ø mm
	l/min	pts/min			l/min	pts/min	
050	0,08	0.16	0,50	190	2,80	5.91	1,90
055	0,12	0.25	0,55	195	2,98	6.29	1,95
060	0,15	0.31	0,60	200	3,16	6.68	2,00
065	0,21	0.44	0,65	205	3,30	6.97	2,05
070	0,25	0.52	0,70	210	3,43	7.24	2,10
075	0,29	0.61	0,75	215	3,58	7.57	2,15
080	0,35	0.74	0,80	220	3,79	8.00	2,20
085	0,41	0.87	0,85	225	3,98	8.41	2,25
090	0,47	0.99	0,90	230	4,18	8.83	2,30
095	0,56	1.18	0,95	235	4,37	9.24	2,35
100	0,65	1.37	1,00	240	4,57	9.66	2,40
105	0,73	1.54	1,05	245	4,80	10.1	2,45
110	0,79	1.67	1,10	250	5,00	10.5	2,50
115	0,88	1.86	1,15	255	5,19	10.9	2,55
120	0,98	1.88	1,20	260	5,37	11.3	2,60
125	1,09	2.30	1,25	265	5,55	11.7	2,65
130	1,18	2.49	1,30	270	5,77	12.1	2,70
135	1,30	2.74	1,35	275	5,99	12.7	2,75
140	1,43	3.02	1,40	280	6,22	13.1	2,80
145	1,56	3.29	1,45	285	6,49	13.7	2,85
150	1,67	3.53	1,50	290	6,74	14.2	2,90
155	1,79	3.78	1,55	295	6,95	14.7	2,95
160	1,92	4.06	1,60	300	7,15	15.1	3,00
165	2,07	4.37	1,65	305	7,31	15.4	3,05
170	2,21	4.67	1,70	310	7,48	15.8	3,10
175	2,36	4.98	1,75	315	7,72	16.3	3,15
180	2,52	5.32	1,80	320	7,98	16.9	3,20
185	2,67	5.64	1,85				

<sup>1)</sup> Up to a nozzle diameter of 1.45 are based at an operational viscosity of 300 mm<sup>2</sup>/s and 20 bar differential pressure, for nozzle diameters of 1.5 and above are valid without correction over the entire viscosity range from 150 to 600 mm<sup>2</sup>/s and differential pressures of 20 to 150 bar.

Accessories

SMB 8



24-0714-3480

SMB 8 mounting plate

Order number	Designation	Flow limiter(s)
24-0714-3477	SMB 8 mounting plate	1
24-0714-3478	SMB 8 mounting plate	2
24-0714-3479	SMB 8 mounting plate	3
24-0714-3480	SMB 8 mounting plate	4
24-0714-3481	SMB 8 mounting plate	5
24-0714-3482	SMB 8 mounting plate	6
24-0711-2403	blind element, to blank off unused mounting	



24-0714-3474

SMB 8 mounting plates with extension for oil filter mounting <sup>1)</sup>

Order number	Designation	Flow limiter(s)
24-0714-3471	SMB 8 mounting plate	1
24-0714-3472	SMB 8 mounting plate	2
24-0714-3473	SMB 8 mounting plate	3
24-0714-3474	SMB 8 mounting plate	4
24-0714-3475	SMB 8 mounting plate	5
24-0714-3476	SMB 8 mounting plate	6
24-0711-2403	blind element, to blank off unused mounting	

<sup>1)</sup> please order oil filter separately



24-0714-3470

SMB 8 interchangeable strainer

for single base plates only

Order number	Designation
24-1874-2106	interchangeable strainer; 300 µm
24-0404-2117	seal kit for interchangeable strainer
24-0714-3470	mounting plate with interchangeable strainer

SMB 8 flow limiter

Order number	Designation
24-1883-3005	flow limiter SMB 8, without nozzle, without signal transmitter
24-0404-2339	seal kit

Oil filter

Order number	Designation
24-0651-3041	oil filter with shut-off valve
24-2104-2009	valve insert with hand wheel
24-0651-2200	filter insert, 100 µm
24-0404-2293	seal kit for filter

## Accessories

# SMB 3/6/8

### Technical data monitoring extension E4/E5/E6

	E4 signal transmitter	E5 signal transmitter	E6 piston detector
Function	magnetic switch	magnetic switch	inductive PNP
Operating temperature	0 to +90 °C; 32 to 194 °F	0 to +90 °C; 32 to 194 °F	0 to +80 °C; 32 to 176 °F
Operating pressure	5–85 bar; 72–1 233 psi	5–85 bar; 72–1 233 psi	5–200 bar; 72–2 900 psi
Material	AlCuMgPb F38, neutrally anodized, connector polyamide	AlCuMgPb F38, neutrally anodized, connector polyamide	AlCuMgPb F37, PBTP, AISI 316Ti connector polyamide
Switching voltage	24 V DC	24–230 V DC	12–36 V DC
Switching voltage ATEX	-	30 V DC	-
ATEX	-	II 3 cII CT6	-
Visual monitoring (LED)	green-yellow	-	-
Dimension length	105 mm; 4.13 in	105 mm; 4.13 in	53 mm; 2.09 in

### SMB 3/6/8 monitoring

Order number	Designation
<b>E4 signal transmitter</b>	
24-1072-2113	signal transmitter without coupler socket
24-1072-2115	signal transmitter with coupler socket with LED 24 V DC
24-1882-2151	coupler socket with LED 24 V DC
<b>E5 signal transmitter</b>	
24-1072-2113	signal transmitter without coupler socket
24-1072-2114	signal transmitter with coupler socket without LED 230 VAC/DC
24-1882-2121	coupler socket without LEDs
<b>E6 piston detector</b>	
24-1884-2282	piston detector
179-990-371	socket straight, 4-pole, M12x1
179-990-372	socket angled, 4-pole, M12x1
179-990-600	socket straight, 4-pole, M12x1 with orange cable, 5 m
179-990-601	socket angled, 4-pole, M12x1 with orange cable, 5 m

### SMB 3/6/8 group monitoring unit

Order number	Designation
84-8011-0369	group monitoring unit for SMB 3, 6 and 8

## Flow limiter

# SMB 9



### Description

The SMB 9 flow limiter is designed to divide the main line flow into parallel, individual flows. The flow is generated independently of system pressure changes and virtually independently of viscosity, guaranteeing a constant flow. The SMB 9 provides a flow rate from 0,08 to 8 l/min (0.16–16.9 pts/min) and a pressure range of up to 50 bar (725 psi). The product has a built-in, gear-wheel-type flow indicator for electronic and visual monitoring of oil flow. Every rotation creates a signal offering information about the flow rate. The SMB 9 can be used in combination with the SKF IPM 12. Also, up to six SMB 9s can be combined on a mounting plate, providing a simple, space-saving installation and compact construction with only one inlet. Various extension options are available.

### Features and benefits

- Stable system regardless of pressure, temperature or viscosity changes
- Reliable product with self-adjusting metering
- Visual and electronic monitoring with real flow indication
- Easy start-up with fixed flow rate via pre-selected nozzle sizes
- Adaptation of flow rate possible (nozzle exchange)

### Applications

- Mining and mineral processing
- Cement
- Pulp and paper industry
- Metal forming; metal fabrication

### Technical data

Function	flow limiter, gear wheel monitoring
Outlets	1–6 on mounting plate
Lubricant	environmentally friendly mineral and synthetic oils; viscosity 20–600 mm <sup>2</sup> /s
Flow rate <sup>1)</sup>	0,08–8 l/min; 0.16–16.9 pts/min
Operating temperature	0 to +70 °C; +32 to 158 °F
Operating pressure	6–50 bar; 87–725 psi
Differential pressure	>6 bar; >87 psi
Electrical connection	hall sensor;
Voltage	24 VDC ±10%; 20mA
Material	AlCuPb F38, neutrally anodized
Connection	plug, DIN 43 650
Protection class	IP 65
Dimensions	80 × 80 × 120 mm 3.15 × 3.15 × 4.72 in
Mounting position	any, filter in upright position
Options	ATEX version for Ex II 2G c TX Gb, Ex II 2D c TX Db

<sup>1)</sup> For technical reasons oil output of the system's feeding pump must be > 10–15% of all flow limiters flow rates mounted in the system.

### NOTE

Further technical information, technical drawings, accessories, spare parts or product function descriptions available on [SKF.com/lubrication](http://SKF.com/lubrication):  
**1-3002 EN; 951-180-072 EN**



# Flow limiter

## SMB 9

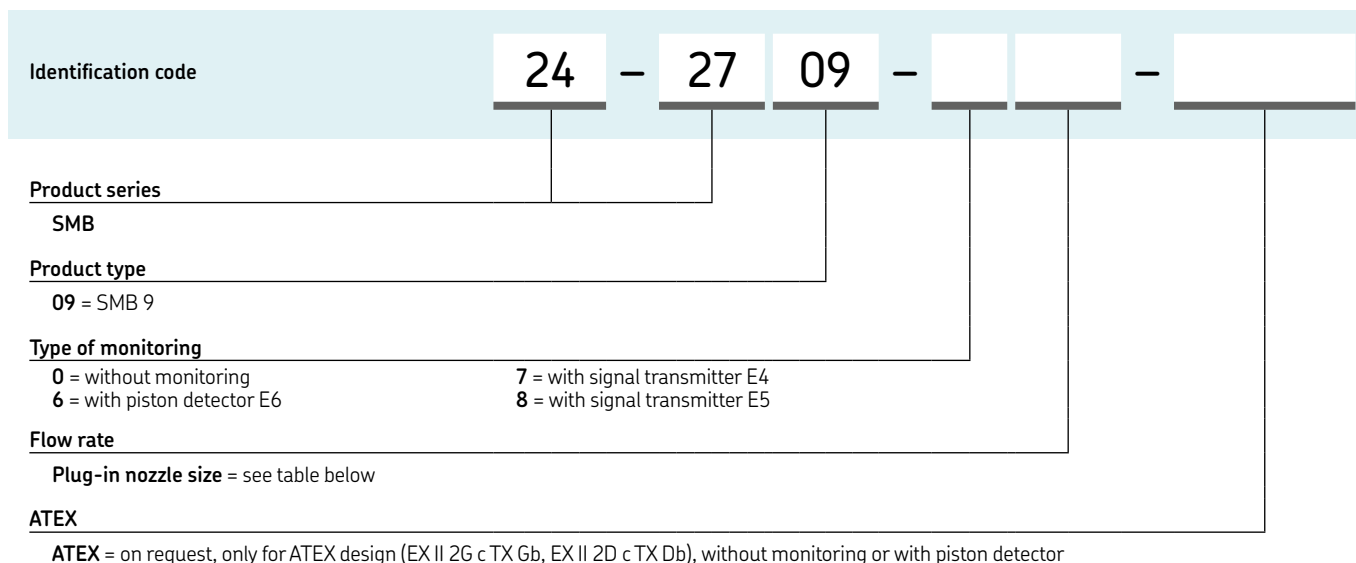

### SMB 9 plug-in nozzle

Order number	Flow rate <sup>1)</sup>		Nozzle Ø mm	Order number	Flow rate <sup>1)</sup>		Nozzle Ø mm
	l/min	pts/min			l/min	pts/min	
050	0,08	0.16	0,50	190	2,80	5.91	1,90
055	0,12	0.25	0,55	195	2,98	6.29	1,95
060	0,15	0.31	0,60	200	3,16	6.68	2,00
065	0,21	0.44	0,65	205	3,30	6.97	2,05
070	0,25	0.52	0,70	210	3,43	7.24	2,10
075	0,29	0.61	0,75	215	3,58	7.57	2,15
080	0,35	0.74	0,80	220	3,79	8.00	2,20
085	0,41	0.87	0,85	225	3,98	8.41	2,25
090	0,47	0.99	0,90	230	4,18	8.83	2,30
095	0,56	1.18	0,95	235	4,37	9.24	2,35
100	0,65	1.37	1,00	240	4,57	9.66	2,40
105	0,73	1.54	1,05	245	4,80	10.1	2,45
110	0,79	1.67	1,10	250	5,00	10.5	2,50
115	0,88	1.86	1,15	255	5,19	10.9	2,55
120	0,98	1.88	1,20	260	5,37	11.3	2,60
125	1,09	2.30	1,25	265	5,55	11.7	2,65
130	1,12	2.49	1,30	270	5,77	12.1	2,70
135	1,30	2.74	1,35	275	5,99	12.7	2,75
140	1,43	3.02	1,40	280	6,22	13.1	2,80
145	1,56	3.29	1,45	285	6,49	13.7	2,85
150	1,67	3.53	1,50	290	6,74	14.2	2,90
155	1,79	3.78	1,55	295	6,95	14.7	2,95
160	1,92	4.06	1,60	300	7,15	15.1	3,00
165	2,07	4.37	1,65	305	7,31	15.4	3,05
170	2,21	4.67	1,70	310	7,48	15.8	3,10
175	2,36	4.98	1,75	315	7,72	16.3	3,15
180	2,52	5.32	1,80	320	7,98	16.9	3,20
185	2,67	5.64	1,85				

<sup>1)</sup> Up to a nozzle diameter of 1.45 are based at an operational viscosity of 300 mm<sup>2</sup>/s and 20 bar differential pressure, for nozzle diameters of 1.5 and above are valid without correction over the entire viscosity range from 150 to 600 mm<sup>2</sup>/s and differential pressures of 20 to 150 bar.

Accessories

SMB 9



SMB 9 mounting plates

Order number	Designation	Flow limiter(s)
24-0714-3171	SMB 9 mounting plate	1
24-0714-3172	SMB 9 mounting plate	2
24-0714-3173	SMB 9 mounting plate	3
24-0714-3174	SMB 9 mounting plate	4
24-0714-3175	SMB 9 mounting plate	5
24-0714-3176	SMB 9 mounting plate	6



SMB 9 mounting plates with extension for oil filter mounting <sup>1)</sup>

Order number	Designation	Flow limiter(s)
24-0714-3181	SMB 9 mounting plate	1
24-0714-3182	SMB 9 mounting plate	2
24-0714-3183	SMB 9 mounting plate	3
24-0714-3184	SMB 9 mounting plate	4
24-0714-3185	SMB 9 mounting plate	5
24-0714-3186	SMB 9 mounting plate	6

<sup>1)</sup> please order oil filter seperately



Oil filter

Order number	Designation
24-0651-3041	oil filter with shut-off valve
24-2104-2009	valve insert with hand wheel
24-0651-2200	filter insert, filter fineness 100 µm
24-0404-2293	seal kit set for filter

## Accessories

### SMB 9

#### SMB 9 interchangeable strainer

Order number	Designation
<b>24-1874-2104</b>	interchangeable strainer SMB 9
<b>24-0404-2117</b>	seal kit set for interchangeable strainer
<b>24-0714-3180</b>	mounting plate for a flow limiter with interchangeable strainer

#### SMB 9 blind element

to blank off unused positions

Order number	Designation
<b>24-0711-2405</b>	blind element, SMB 9
<b>95-0038-0908</b>	screw plug G $\frac{3}{8}$ for SMB 9 <sup>1)</sup>

<sup>1)</sup> One screw plug for dummy element has to be ordered

#### SMB 9 spare parts

Order number	Designation
<b>24-1883-3012</b>	SMB 9 without nozzle, without electrical monitoring
<b>24-1883-3010</b>	SMB 9 without nozzle, with electrical monitoring
<b>24-0404-2340</b>	seal kit for SMB 9
<b>179-990-033</b>	Socket

#### SMB 9 group monitoring

Order number	Designation
<b>84-8011-0380</b>	IPM 12 pulse meter for SMB 9, 10, 13 and 14
<b>84-8011-0390</b>	IPM 12 pulse meter with connection socket for PGA 3



IPM 12

## Flow limiter

# SMB 10



### Description

The SMB 10 flow limiter is designed to divide the main line flow into parallel, individual flows. The flow is generated independently of system pressure changes and virtually independently of viscosity, guaranteeing a constant flow. The SMB 10 provides a flow rate from 0,21 to 8 l/min (0.44–17.2 pts) and a pressure range of up to 50 bar (725 psi). The SMB 10 can reduce the starting flow to 25% to prevent cold bearings from overflowing. The change-over can be done with a hydraulic or electric change-over valve. Up to six SMB 10s can be combined on a mounting plate, providing a simple, space-saving installation and compact construction with only one inlet. Various extension options are available. For visual and electronic monitoring of oil flow, the SMB 10 has a built-in, gear-wheel-type flow indicator. Every rotation creates a signal offering information about the flow rate. The SMB 10 can be used in combination with the SKF IPM 12 pulse meter.

### Features and benefits

- Stable system regardless of pressure, temperature or viscosity changes
- Reliable product with self-adjusting metering
- Visual and electronic monitoring with real flow indication
- Adaptation of flow rate possible (nozzle exchange)
- Optional ATEX version for Ex II 2G c T4 Gb

### Applications

- Pulp and paper industry
- Metal industry
- Heavy industry

### Technical data

Function	changeover 2-way flow limiter with volumetric flow control
Outlets	1–6 on mounting plate
Lubricant	environmentally friendly mineral and synthetic oils; viscosity 20–600 mm <sup>2</sup> /s
Flow rate <sup>1)</sup>	0,21–8,15 l/min; 0.44–17.2 pts/min
Operating temperature	0 to +70 °C; +32 to 158 °F
Operating pressure	7–50 bar; 102–725 psi
Differential pressure	>7 bar; >101 psi
Electrical connection	Hall sensor
Voltage	24 V DC ±10%; 20mA
Material	AlCuPb F38, neutrally anodized
Connection	plug, DIN 43 650
Protection class	IP 65
Dimensions	80 × 80 × 120 mm 3.15 × 3.15 × 4.72 in
Mounting position	any, filter in vertical position

<sup>1)</sup> For technical reasons oil output of the system's feeding pump must be > 10–15% of all flow limiters flow rates mounted in the system.

### NOTE

Further technical information, technical drawings, accessories, spare parts or product function descriptions available on [SKF.com/lubrication](http://SKF.com/lubrication):  
**1-3003-EN; 951-180-072 EN**



# Flow limiter

## SMB 10

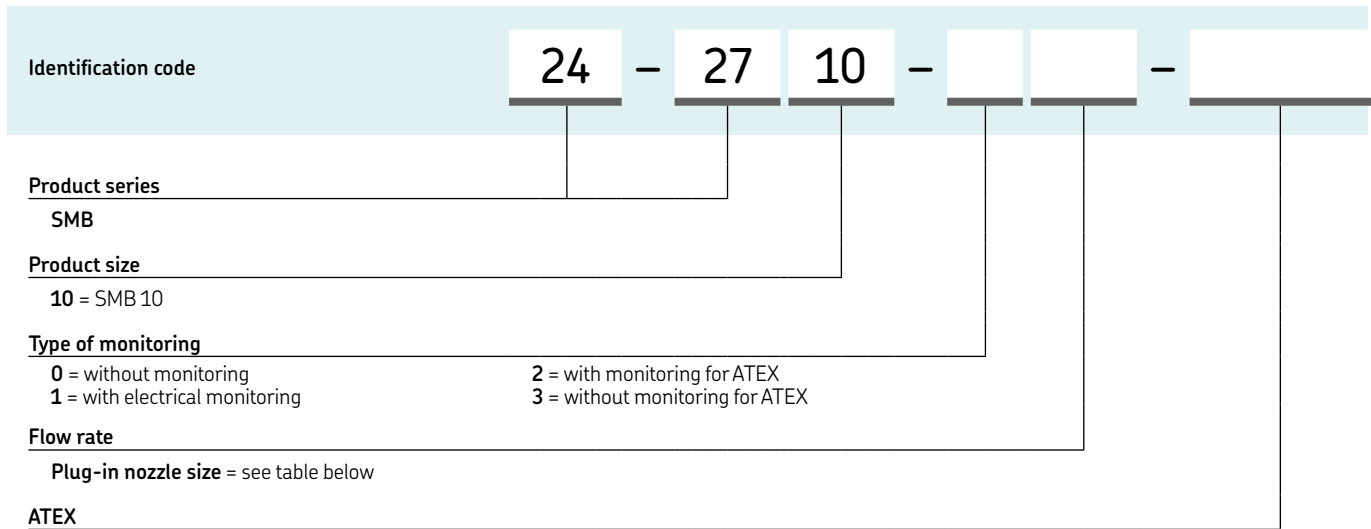

### SMB 10 with a starting operating volumetric flow ratio 1:4

Order number	Flow rate <sup>1)</sup>		Nozzle Ø mm	Order number	Flow rate <sup>1)</sup>		Nozzle Ø mm
	l/min	pts/min			l/min	pts/min	
003	0,21 : 0,85	0.44 : 1.79	0,55-1,10	120	0,98	2.07	5,5-1,20
004	0,26 : 1,02	0.55 : 2.16	0,55-1,10	125	1,09	2.30	5,5-1,25
005	0,30 : 1,22	0.63 : 2.58	0,60-1,20	130	1,18	2.49	5,5-1,30
006	0,36 : 1,43	0.76 : 3.02	0,65-1,30	135	1,30	2.75	5,5-1,35
007	0,41 : 1,66	0.87 : 3.50	0,70-1,40	140	1,43	3.02	5,5-1,40
008	0,48 : 1,91	1.01 : 4.04	0,75-1,50	145	1,56	3.30	5,5-1,45
009	0,54 : 2,17	1.14 : 4.59	0,80-1,60	150	1,67	3.53	5,5-1,50
010	0,61 : 2,45	1.29 : 5.18	0,85-1,70	155	1,79	3.78	5,5-1,55
011	0,69 : 2,75	1.46 : 5.81	0,90-1,80	160	1,92	4.06	5,5-1,60
012	0,76 : 3,06	1.60 : 6.47	0,95-1,90	165	2,07	4.37	5,5-1,65
013	0,85 : 3,39	1.79 : 7.16	1,00-2,00	170	2,21	4.67	5,5-1,70
014	0,93 : 3,74	1.97 : 7.90	1,05-2,10	175	2,36	4.99	5,5-1,75
015	1,02 : 4,10	2.16 : 8.66	1,10-2,20	180	2,52	5.33	5,5-1,80
016	1,12 : 4,49	2.37 : 9.49	1,15-2,30	185	2,67	5.33	5,5-1,85
017	1,22 : 4,88	2.58 : 10.3	1,20-2,40	190	2,80	5.64	5,5-1,90
018	1,32 : 5,30	2.79 : 11.2	1,25-2,50	195	2,985	5.92	5,5-1,95
019	1,43 : 5,73	3.02 : 12.1	1,30-2,60	200	3,16	6.30	5,5-2,00
020	1,55 : 6,18	3.27 : 13.0	1,35-2,70	205	3,306	6.68	5,5-2,05
021	1,66 : 6,65	3.50 : 14.0	1,40-2,80	210	3,43	6.97	5,5-2,10
022	1,78 : 7,13	3.76 : 15.0	1,45-2,90	215	3,58	7.25	5,5-2,15
023	1,91 : 7,63	4.03 : 16.1	1,50-3,00	220	3,79	7.57	5,5-2,20
024	2,04 : 8,14	4.31 : 17.2	1,55-3,10	225	3,988	8.01	5,5-2,25

### SMB 10 without starting reduction – ratio 1:1

050	0,08	0.17	5,5-0,50	240	4,57	9.24	5,5-2,40
055	0,12	0.25	5,5-0,55	245	4,80	9.66	5,5-2,45
060	0,15	0.32	5,5-0,60	250	5,00	10.14	5,5-2,50
065	0,20	0.42	5,5-0,65	255	5,19	10.57	5,5-2,55
070	0,25	0.55	5,5-0,70	260	5,37	10.97	5,5-2,60
075	0,29	0.61	5,5-0,75	265	5,55	11.35	5,5-2,65
080	0,35	0.74	5,5-0,80	270	5,77	11.73	5,5-2,70
085	0,41	0.87	5,5-0,85	275	5,99	12.19	5,5-2,75
090	0,47	0.99	5,5-0,90	280	6,22	12.66	5,5-2,80
095	0,56	1.18	5,5-0,95	285	6,49	13.15	5,5-2,85
100	0,65	1.37	5,5-1,00	290	6,74	13.72	5,5-2,90
105	0,73	1.54	5,5-1,05	295	6,95	14.24	5,5-2,95
110	0,79	1.67	5,5-1,10	300	7,15	14.69	5,5-3,00
115	0,88	1.86	5,5-1,15	305	7,31	15.11	5,5-3,05
				310	7,48	15.45	5,5-3,10

<sup>1)</sup> at an operating viscosity of 300 mm<sup>2</sup>/s

Accessories

# SMB 10



**SMB 10 mounting plates with extension for hydraulic changeover valve mounting <sup>1)</sup>**

Order number	Designation	Flow limiter(s)
24-0714-3231	SMB 10 mounting plate	1
24-0714-3232	SMB 10 mounting plate	2
24-0714-3234	SMB 10 mounting plate	4
24-0714-3236	SMB 10 mounting plate	6

<sup>1)</sup> please order changeover valve separately



**SMB 10 mounting plates with extension for hydraulic changeover valve and oil filter mounting <sup>1)</sup>**

Order number	Designation	Flow limiter(s)
24-0714-3241	SMB 10 mounting plate	1
24-0714-3242	SMB 10 mounting plate	2
24-0714-3244	SMB 10 mounting plate	4
24-0714-3246	SMB 10 mounting plate	6
24-0714-3164	blind plate to close filter ports	

<sup>1)</sup> please order changeover valve and oil filter separately



**SMB 10 mounting plates with extension for electrical changeover valve and oil filter mounting <sup>1)</sup>**

Order number	Designation	Flow limiter(s)
24-0714-3261	SMB 10 mounting plate	1
24-0714-3262	SMB 10 mounting plate	2
24-0714-3263	SMB 10 mounting plate	3
24-0714-3264	SMB 10 mounting plate	4
24-0714-3265	SMB 10 mounting plate	5
24-0714-3266	SMB 10 mounting plate	6
24-0714-3164	blind plate to close filter ports	

<sup>1)</sup> please order changeover valve and oil filter separately

# SMB 10



### SMB 10 oil filter

Order number	Designation
24-0651-3041	oil filter with shut-off valve
24-2104-2009	valve insert with hand wheel
24-0651-2200	filter insert, filter fineness 100 µm
24-0404-2293	seal kit filter



### SMB 10 change-over valve

Order number	Designation
24-1883-2093	hydraulic change-over valve
24-1254-2486	electrical change-over valve 24 V DC
24-1254-2487	electrical change-over valve 230 V AC
24-0404-2281	seal kit hydraulic change-over valve

### SMB 10 group monitoring

Order number	Designation
84-8011-0380	IPM 12 pulse meter for SMB 9, 10, 13 and 14
84-8011-0390	IPM 12 pulse meter with connection socket for PGA 3

### SMB 10 spare parts

Order number	Designation
24-1883-3020	SMB 10 without nozzle, without electrical monitoring
24-0404-2341	Seal kit for SMB 10
24-0758-2113	Sight glass (with flange, seals and shims)

### SMB 10 blind element to blank off unused positions

Order number	Designation
24-0711-2406	blind element SMB 10

## Flow limiter

# SMB 13



### Description

The SMB 13 flow limiter is designed to divide the main line flow into parallel, individual, volumetric flow quantities and to “limit” these according to requirements. The flow is generated independently of system pressure and virtually independently of viscosity, guaranteeing a constant flow. The SMB 13 provides a flow rate from 6 to 30 l/min (12.6–63.4 pts/min) and a pressure range up to 50 bar (725 psi). The flow limiter has a built-in, gear-wheel-type flow indicator for electronic and visual monitoring of oil flow. Every rotation creates a signal offering information about the flow rate. The SMB 13 can be used in combination with the IPM 12.

### Features and benefits

- Stable system regardless of pressure, temperature or viscosity changes
- Visual and electronic monitoring with real flow indication
- Easy start-up with fixed flow rate via pre-selected nozzle sizes
- Adaptation of flow rate possible (nozzle exchange)
- Optional ATEX version for Ex II 2G c TX Gb, Ex II 2D c TX Db

### Applications

- Mining
- Presses
- Cement
- Heavy industry

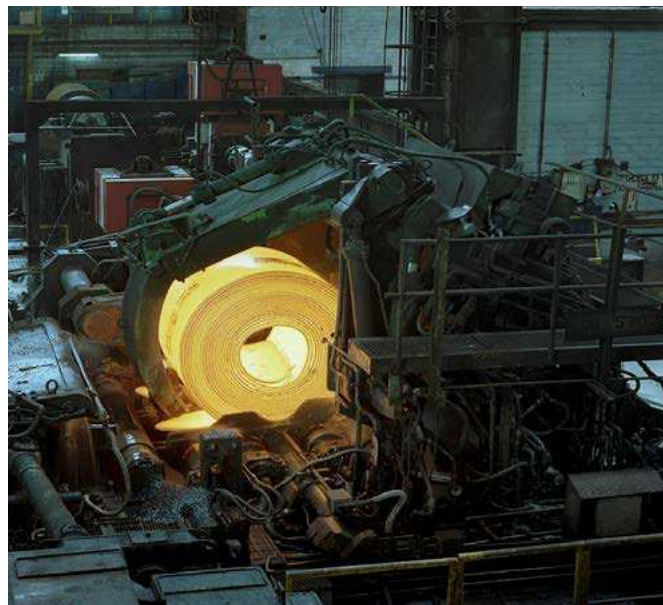

### Technical data

Function	flow limiter 2-way with volumetric flow control
Outlets	1
Lubricant	environmentally friendly, mineral and synthetic oils; viscosity 20–600 mm <sup>2</sup> /s
Flow rate <sup>1)</sup>	6,0–30 l/min; 12.7–63.4 pts/min
Operating temperature	0 to +70 °C; +32 to 158 °F
Operating pressure	6–50 bar 87–725 psi
Differential pressure	>6 bar >87 psi
Material	AlCuPb F38, neutrally anodized
Electrical sensor	Hall sensor
Voltage	24 V DC ± 10%
Current switch	max. 20 mA
Connection	plug, DIN 43 650
Protection class	IP 65
Dimension	115 × 120 × 128,5 mm 4.53 × 4.72 × 5.06 in
Mounting position	any

<sup>1)</sup> For technical reasons oil output of the system's feeding pump must be > 10–15% of all flow limiters flow rates mounted in the system.

### NOTE

Further technical information, technical drawings, accessories, spare parts or product function descriptions available on [SKF.com/lubrication](http://SKF.com/lubrication):  
**1-3004-EN; 951-180-072 EN**

## Flow limiter

# SMB 13

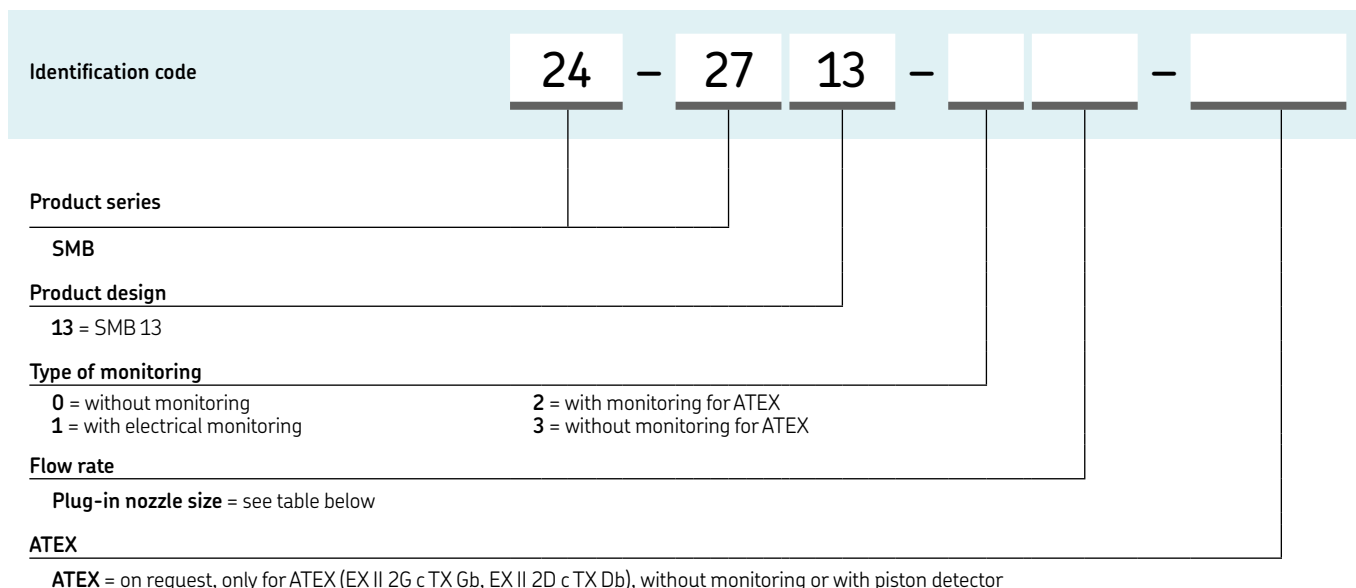

### SMB 13 plug-in nozzle

Order number	Flow rate <sup>1)</sup>		Nozzle Ø mm
	l/min	pts/min	
250	6,00	12.6	2,50
260	6,50	13.7	2,60
270	6,75	14.2	2,70
280	7,00	14.8	2,80
290	7,50	15.6	2,90
300	8,00	16.9	3,00
310	8,75	18.5	3,10
320	9,25	19.5	3,20
330	9,75	20.6	3,30
340	10,50	22.1	3,40
350	11,00	23.2	3,50
360	11,50	24.3	3,60
370	12,00	25.4	3,70
380	12,75	26.9	3,80
390	13,50	28.5	3,90
400	14,00	29.6	4,00
410	14,75	31.1	4,10
420	15,50	32.8	4,20
430	16,00	33.8	4,30
440	16,75	35.4	4,40
450	17,50	36.9	4,50
460	18,00	38.0	4,60
470	18,75	39.6	4,70
480	19,50	41.2	4,80
490	20,25	42.8	4,90
500	21,00	44.4	5,00
510	21,75	45.9	5,10
520	22,50	47.6	5,20
530	23,25	49.1	5,30
540	24,00	50.7	5,40
550	25,00	52.8	5,50
560	26,00	54.9	5,60
570	27,00	57.0	5,70
580	28,00	59.1	5,80
600	30,00	63.4	6,00

<sup>1)</sup> at an operating viscosity of 300 mm<sup>2</sup>/s

### SMB 13 group monitoring

Order number	Designation
<b>84-8011-0380</b>	IPM 12 pulse meter
<b>84-8011-0390</b>	IPM 12 pulse meter with connection socket for PGA 3

### SMB 13 flow limiter

Order number	Designation
<b>24-1883-3016</b>	SMB 13 without nozzle, with electrical monitoring

### SMB 13 accessories

Order number	Designation
<b>44-0758-2049</b>	sight glass D45x12
<b>24-0404-2310</b>	gasket set: gasket D32/45x05 O-ring 44x3 O-ring 90x3
<b>24-1882-2029</b>	socket



## Flow limiter

# SMB 14



### Description

The SMB 14 flow limiter is designed to divide the main line flow into parallel, individual, volumetric flow quantities and to “limit” these according to requirements. The flow is generated independently of system pressure and virtually independently of viscosity, guaranteeing a constant flow. The SMB 14 provides a flow rate from 25 to 100 l/min (52.8–211.3 pts/min) and a pressure range up to 50 bar (725 psi). It has a built-in, gear-wheel-type flow indicator for electronic and visual monitoring of oil flow. Every rotation creates a signal offering information about the flow rate. SMB 14 flow limiter can be used in combination with the SKF IPM 12.

### Features and benefits

- Stable system regardless of pressure, temperature or viscosity changes
- Visual and electronic monitoring with real flow indication
- Easy start-up with fixed flow rate via pre-selected nozzle sizes
- Adaptation of flow rate possible (nozzle exchange)
- Optional ATEX version for Ex II 2G c TX Gb, Ex II 2D c TX Db

### Applications

- Metal industry
- Automation
- Heavy industry



### Technical data

Function	2-way flow limiter valve with volumetric flow check
Outlets	1
Lubricant	environmentally friendly, mineral and synthetic oils; viscosity 20–600 mm <sup>2</sup> /s
Flow rate <sup>1)</sup>	25–132 l/min 52.8 - 278.9 pts/min
Operating temperature	0 to +70 °C +32 to 158 °F
Operating pressure	6–50 bar 87–725 psi
Differential pressure	>6 bar >87 psi
Material	AlCuPb F38, neutrally anodized
Electrical connection	hall sensor
Voltage	24 VDC ±10%
Current switch	max. 20 mA
Connection	plug, DIN 43 650
Protection class	IP 65
Dimensions	150 × 180 × 190 mm 5.91 × 7.09 × 7.48 in
Mounting position	any

<sup>1)</sup> For technical reasons oil output of the system's feeding pump must be > 10–15% of all flow limiters flow rates mounted in the system. Higher metering quantities available on request

### NOTE

Further technical information, technical drawings, accessories, spare parts or product function descriptions available on [SKF.com/lubrication](http://SKF.com/lubrication):  
**1-3005-EN; 951-180-072 EN**

## Flow limiter

# SMB 14

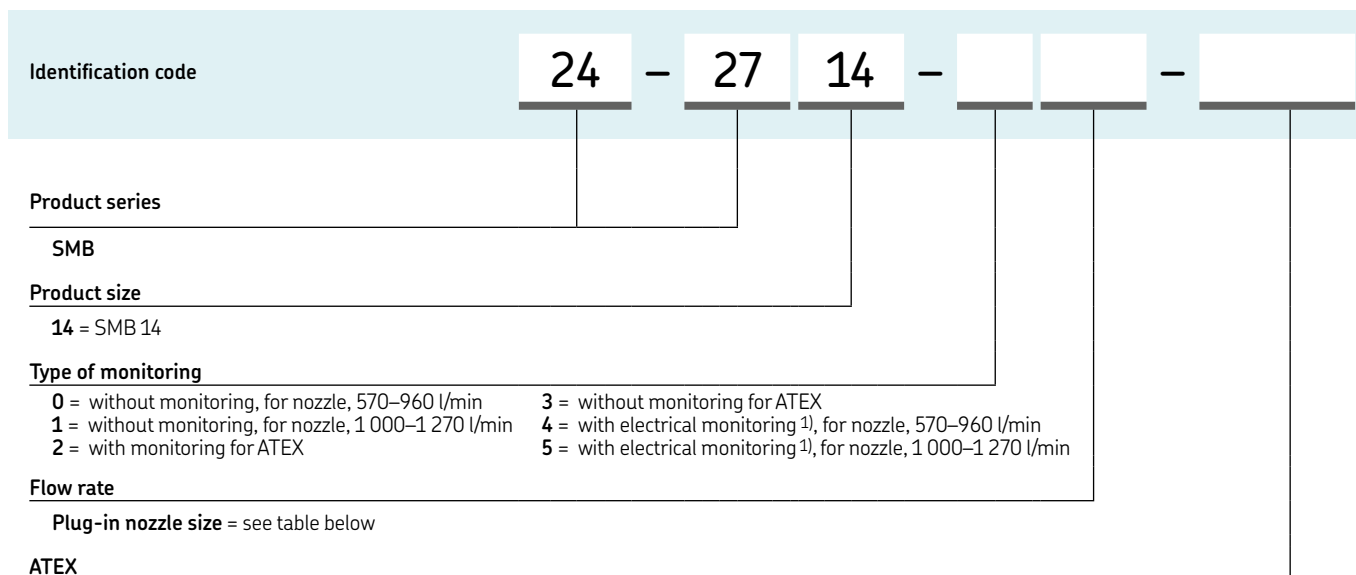

<sup>1)</sup> with electrical monitoring, (PNP technology, 24 V DC) continuous pulse sequence, proportional to volumetric flow

### SMB 14 plug-in nozzle

Order number	Flow rate <sup>1)</sup>		Nozzle Ø mm
	l/min	pts/min	
44-0455-2357	25	52.8	5,70
44-0455-2360	30	63.4	6,30
44-0455-2363	35	73.9	6,80
44-0455-2365	40	84.5	7,30
44-0455-2367	45	95.1	7,80
44-0455-2369	50	105.7	8,20
44-0455-2371	55	116.2	8,70
44-0455-2373	60	126.8	9,10
44-0455-2374	65	137.4	9,60
44-0455-2375	70	147.9	10,00
44-0455-2376	75	158.5	10,40
44-0455-2377	80	169.0	10,80
44-0455-2378	90	190.2	11,70
44-0455-2379	100	211.3	12,70
44-0455-2385	105	221.9	13,10
44-0455-2380	110	232.4	13,50
44-0455-2381	116	245.1	14,00
44-0455-2386	120	253.6	14,40
44-0455-2382	132	278.9	15,30

<sup>1)</sup> at an operating viscosity of 300 mm<sup>2</sup>/s

### SMB 14 group monitoring

Order number	Designation
84-8011-0380	IPM 12 pulse meter
84-8011-0390	IPM 12 pulse meter with connection socket for PGA 3

### SMB 14 flow limiter

Order number	Designation
24-1883-3017	SMB 14 without nozzle, with electrical monitoring

### SMB 14 accessories

Order number	Designation
44-0758-2049	sight glass, D45x12
24-0404-2311	gasket set: gasket D32/45x05 O-ring 44x3 O-ring 90x3
24-1882-2029	socket

## Progressive metering device

# PSG1



### Description

The PSG1 is a progressive metering device consisting of a baseplate and different metering sections that can be individually combined for specific outlet ratios and cross portings. The ports are part of the baseplate, so that connectors and tubes remain in place when segments need to be changed.

### Features and benefits

- Easy servicing as outlets are located on baseplate
- Flexible due to exchangeable metering segments
- Visual or electrical monitoring possible
- Dummy segments with no output available
- Adjustable by consolidating outlets internally or externally

### Applications

- Automobile presses
- Paper machines
- Tunnel boring machines

### Technical data

Function	segmented progressive metering device
Outlets	6 to 20
Lubricant	grease: up to NLGI 2 mineral and synthetic oils; min. viscosity 12 mm <sup>2</sup> /s
Metering quantity	per cycle and outlet:
min.	0,05 cm ; 0.003 in
max.	0,25 cm ; 0.015 in
Flow rate	max. 0,8 l/min; 0.17 pts/min
Operating temperature	-15 to +110 °C; 5 to 230 °F
Operating pressure <sup>1)</sup>	200 bar; 2 900 psi
Material	
baseplate:	aluminum alloy
sections:	steel galvanized
Inlet connection	G 1/8
Outlet connection	G 1/8
Protection class	IP 67
Dimensions	min. 90 × 55 × 41 mm max. 244 × 55 × 41 mm min. 3.54 × 2.17 × 1.61 in max. 9.61 × 2.17 × 1.61 in
Mounting position:	
on machines without vibration	any
on machines with vibration	piston position should be 90° to machine's movement direction

<sup>1)</sup> Operating pressure may be lower depending on design with monitoring or attachments

### PSG1 accessories

Order number	Designation
466-419-001	Closure plug for baseplate outlet incl. washer
24-2151-3760	Crossporting bridge, 2 outlets <sup>1)</sup>
24-2151-3762	Crossporting bridge, 2 outlets, with outlet port <sup>1)</sup>
24-2151-3764	Crossporting bridge, 2 outlets, with outlet port and check valve <sup>1)</sup>

<sup>1)</sup> bridges are approved for a maximum operating pressure of 100 bar; crossporting bridge also available for 3 outlets, see brochure



### NOTE

Further technical information, technical drawings, accessories, spare parts or product function descriptions available on [SKF.com/lubrication](http://SKF.com/lubrication):  
**14389EN; 951-230-013**



3D  
[skf-lubrication.partcommunity.com/3d-cad-models](http://skf-lubrication.partcommunity.com/3d-cad-models)

# Progressive metering device

## PSG1

Identification code	PSG1	X	X	X	
Product series					
Monitoring					
<p>X = none</p> <p>3 = 3-pin piston detector, M12x1 plug</p> <p>Y = cycle indicator, visual plunger rod <sup>1) 2)</sup></p> <p>S = cycle indicator with bracket and proximity switch <sup>1) 2)</sup></p> <p>G = cycle indicator with bracket for proximity switch (without proximity switch) <sup>1) 2)</sup></p>					
Position of monitoring device <sup>2)</sup>					
<p>X = none</p> <p>A = left, section 1                      B = right, section 1</p> <p>C = left, section 2                      D = right, section 2</p> <p>E = left, section 3                      F = right, section 3</p> <p>G = left, section 4                      H = right, section 4</p> <p>J = left, section 5                      K = right, section 5</p> <p>L = left, section 6                      M = right, section 6</p> <p>N = left, section 7                      P = right, section 7</p> <p>Q = left, section 8                      R = right, section 8</p> <p>S = left, section 9                      T = right, section 9</p> <p>U = left, section 10                      V = right, section 10</p>					
Connector baseplate inlet <sup>3)</sup>					
<p>X = none</p> <p>A = tube Ø6 mm</p>	<p>B = tube Ø8 mm</p> <p>C = tube Ø10 mm</p>				
Sections					

... = to be configured in the section configurator below

Identification code	-	-	
Section (minimum 3 sections) <sup>4)</sup>			
<p>X = dummy section</p> <p>A = 0,05 cm<sup>3</sup>/cycle <sup>5)</sup></p> <p>E = 0,25 cm<sup>3</sup>/cycle</p>	<p>B = 0,10 cm<sup>3</sup>/cycle</p> <p>D = 0,20 cm<sup>3</sup>/cycle</p>		
Outlet connector left			
<p>S = outlet closed by screw plug <sup>6)</sup></p> <p>X = outlet without fitting</p>			
Outlet connector right			
<p>S = outlet closed by screw plug <sup>6)</sup></p> <p>X = outlet without fitting</p>			

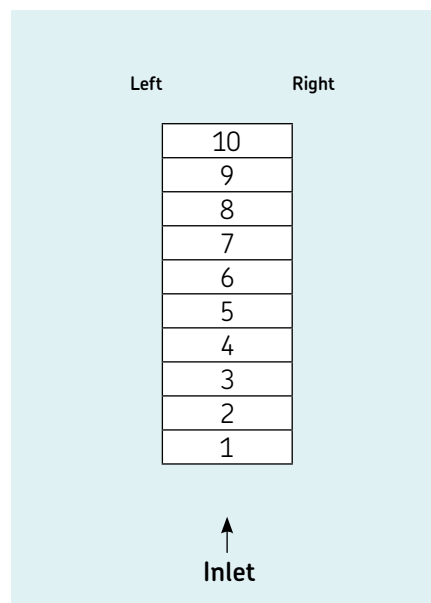

<sup>1)</sup> Only on 200 and 250 mm<sup>3</sup> section sizes  
<sup>2)</sup> Installation on first or last section is not recommended  
<sup>3)</sup> Solderless pipe union with cutting sleeve per DIN 2353  
<sup>4)</sup> The volume per section is equal on both sides  
<sup>5)</sup> If possible, do not place in first position when designing metering device  
<sup>6)</sup> Metering device only operates with one side (left or right) outlet closed per section

## Progressive metering device

# PSG2

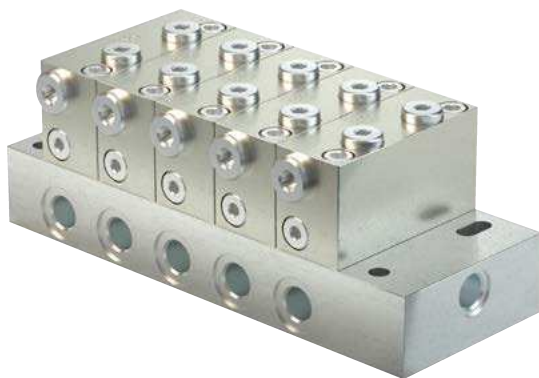

### Description

The PSG2 is a progressive metering device consisting of a baseplate and different metering sections that can be individually combined for specific outlet ratios and cross portings. The ports are part of the baseplate, so that connectors and tubes remain in place when segments need to be changed.

### Features and benefits

- Easy servicing due to outlet location
- Flexible with exchangeable metering segments
- Visual or electrical monitoring available
- Increased corrosion-resistant material
- Adjustable output by consolidating outlets internally or externally

### Applications

- Automobile presses
- Tunnel boring machines
- Paper machines

### Technical data

Function	segmented progressive metering device
Outlets	6 to 20
Lubricant	grease: up to NLGI 2 mineral and synthetic oils; min. viscosity of 12 mm <sup>2</sup> /s
Metering quantity	per cycle and outlet:
min.	0,06 cm <sup>3</sup> ; 0.0037 in <sup>3</sup>
max.	0,84 cm <sup>3</sup> ; 0.051 in <sup>3</sup>
Flow rate	max. 2,5 l/min; 5.3 pts/min
Operating temperature	-15 to +110 °C; +5 to +230 °F
Operating pressure <sup>1)</sup>	200 bar; 2 900 psi
Material	
baseplate:	aluminium alloy or anodized
sections:	steel or nickel plated
Inlet connection	G 1/4
Outlet connection	G 1/4
Protection class	IP67
Dimensions	min. 131 × 86 × 71 mm max. 327 × 86 × 71 mm min. 5.16 × 3.39 × 2.80 in max. 12.87 × 3.39 × 2.80 in
Mounting position:	
on machines without vibration	any
on machines with vibration	piston position should be 90° to machine movement direction
Options	flow limiter

<sup>1)</sup> Operating pressure may be lower depending on design with monitoring or attachments

### PSG2 accessories

Order number	Designation
466-419-001	Closure plug for baseplate outlet incl. washer
24-2151-3760	Crossporting bridge, 2 outlets <sup>1)</sup>
24-2151-3762	Crossporting bridge, 2 outlets, with outlet port <sup>1)</sup>
24-2151-3764	Crossporting bridge, 2 outlets, with outlet port and check valve <sup>1)</sup>

<sup>1)</sup> Bridges are approved for a maximum operating pressure of 100 bar; crossporting bridge also available for 3 outlets, see brochure



### NOTE

Further technical information, technical drawings, accessories, spare parts or product function descriptions available on [SKF.com/lubrication](http://SKF.com/lubrication):  
**14389 EN; 951-230-01**



3D

[skf-lubrication.partcommunity.com/3d-cad-models](http://skf-lubrication.partcommunity.com/3d-cad-models)





## Progressive metering device

# PSG3

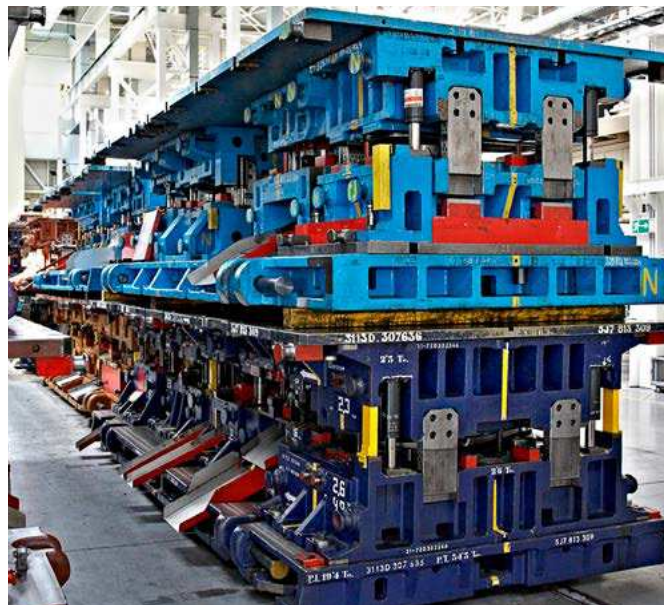
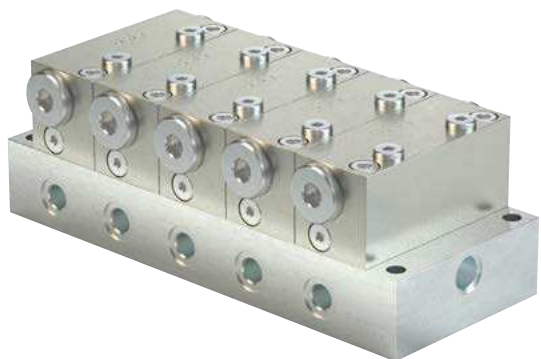

### Description

The PSG3 is a progressive metering device consisting of a baseplate and different metering sections that can be individually combined for specific outlet ratios and cross portings. The ports are part of the baseplate, so that connectors and tubes remain in place when segments need to be changed.

### Features and benefits

- Easy servicing as outlets are located on baseplate
- Flexible with exchangeable metering segments
- Visual or electrical monitoring available
- Increased corrosion-resistant material available
- Dummy segments without output available
- Adjustable output by consolidating outlets internally or externally
- Main metering device in oil circulation systems

### Applications

- Automobile presses
- Paper machines
- Tunnel boring machines

### Technical data

Function	segmented progressive metering device
Outlets	6 to 20
Lubricant	grease up to NLGI 2 mineral and synthetic oils; min. viscosity 12 mm <sup>2</sup> /s
Metering quantity	per cycle and outlet:
min.	0,80 cm 0,049 in
max.	3,20 cm 0,195 in
Flow rate	max. 6 l/min; 12.7 pts/min
Operating temperature	-15 to +110 °C; +5 to +230 °F
Operating pressure <sup>1)</sup>	200 bar 2 900 psi
Material	
baseplate:	aluminium alloy or anodized
sections:	steel galvanized or nickel plated
Inlet connection	G 3/8
Outlet connection	G 1/4
Protection class	IP 67
Dimensions	min. 165 × 108 × 88 mm max. 466 × 108 × 88 mm min. 6.50 × 4.25 × 3.46 in max. 18.35 × 4.25 × 3.46 in
Mounting position:	
on machines without vibration	any
on machines with vibration	piston position must be in 90° angle to machine's movement direction
Options	flow limiter

<sup>1)</sup> Operating pressure may be lower depending on design with monitoring or attachments

### PSG3 accessories

Order number	Designation
DIN908-R1-4-5.8	Closure plug for baseplate outlet
508-108	Washer for closure plug
24-2151-3734	Crossporting bridge, 2 outlets <sup>1)</sup>
24-2151-3736	Crossporting bridge, 2 outlets with outlet ports <sup>1)</sup>

<sup>1)</sup> Crossporting bridges are approved for a maximum operating pressure of 100 bar; crossporting bridge also available for 3 outlets, see brochure



### NOTE

Further technical information, technical drawings, accessories, spare parts or product function descriptions available on [SKF.com/lubrication](http://SKF.com/lubrication):  
**14389 EN; 951-230-013**



3D

[skf-lubrication.partcommunity.com/3d-cad-models](http://skf-lubrication.partcommunity.com/3d-cad-models)



## Progressive metering device

### VP



### Description

The VP type metering device is a sectional metering device. Its metering sections cover a metering volume per outlet and cycle of  $0,1 \text{ cm}^3$  (T-section = 2 outlets) to  $1,2 \text{ cm}^3$  (S-section = 1 outlet). All sections (inlet, intermediate, end) are tightened via tie rods. The delivery ducts are sealed by porting plates in between the segments. A minimum of three intermediate sections is necessary.

### Features and benefits

- Volumetric flow of up to  $1,0 \text{ l/min}$ ;  $2,1 \text{ pts/min}$
- Universal use in continuous or intermittent operation
- Metering sections with variable metering amount
- Internal and external consolidation of outlets
- Visual or electrical monitoring optional
- Ideal as main metering device
- All outlets with built-in, non-return valves

### Applications

- Preferred master metering device
- Metal forming machines
- Vehicles, trucks
- Construction and mining
- Packaging machines
- General industry
- Farm machinery

### Technical data

Function	sectional metering device
Outlets	6 to 20
Lubricant	grease up to NLGI 2; environmentally friendly mineral and synthetic oils; viscosity min. $12 \text{ mm}^2/\text{s}$
Metering quantity	per cycle and outlet: $0,1\text{--}1,2 \text{ cm}^3$ ; $0,006\text{--}0,073 \text{ in}^3$ $1 \text{ l/min}$ ; $2,1 \text{ pts/min}$
Flow rate	
Operating temperature	$-25$ to $+90 \text{ }^\circ\text{C}$ ; $-13$ to $194 \text{ }^\circ\text{F}$
Operating pressure	oil: $200 \text{ bar}$ ; $2\,900 \text{ psi}$ grease: $200 \text{ bar}$ ; $2\,900 \text{ psi}$
Material:	
inlet, separator and end plate	steel, galvanized/NBR
sections/piston plate	steel, galvanized
Inlet connection:	
VPM/VPG	$M14 \times 1,5 / G\ 1/4$
Outlet connection:	
VPM/VPG	$M10 \times 1 / G\ 1/8$
Protection class	IP 67
Dimensions	min. $98 \times 82,5 \times 41 \text{ mm}$ max. $238 \times 82,5 \times 41 \text{ mm}$ min. $3,86 \times 3,25 \times 1,61 \text{ in}$ max. $9,37 \times 3,25 \times 1,61 \text{ in}$
Mounting position:	
on machines without vibration	any
on machines with vibration	piston position must be in $90^\circ$ angle to machine's movement direction



### NOTE

Further technical information, technical drawings, accessories, spare parts or product function descriptions available on [SKF.com/lubrication](http://SKF.com/lubrication):

**15400EN, 951-230-008 EN**



3D

[skf-lubrication.partcommunity.com/3d-cad-models](http://skf-lubrication.partcommunity.com/3d-cad-models)

# Progressive metering device

## VP

<b>Identification code</b>	VP			A				X	
<b>Product series</b>	VP								
<b>Connections</b>	A								
M = M14×1,5 inlet thread; M10×1 outlet thread G = G 1/4 inlet thread; G 1/8 outlet thread									
<b>Monitoring</b>	X								
X = none 2 = 2-pin piston detector, M12×1 plug 3 = 3-pin piston detector, M12×1 plug (wire breaking detection) Y = cycle indicator, visual (plunger rod) <sup>1)</sup>									
<b>Plug-on</b>	A								
A = flow limiter SMB 8 with nominal volume up to 1,09 l/min; 2.3 pts/min									
<b>Plug-in nozzle for flow limiter</b>	A								
see PUB 1-3016 EN, p. 12									
<b>Position of monitoring device <sup>2)</sup></b>	X								
X = none A = left, section 1 C = left, section 2 E = left, section 3 G = left, section 4 J = left, section 5 L = left, section 6 N = left, section 7 D = right, section 2 F = right, section 3 H = right, section 4 K = right, section 5 M = right, section 6 P = right, section 7 Q = left, section 8 S = left, section 9 U = left, section 10 R = right, section 8 T = right, section 9 V = right, section 10									
<b>Inlet connector <sup>2) 3)</sup></b>	X								
X = none A = VPM straight connector, tube Ø6 mm (L) D = VPM straight connector, tube Ø8 mm (S) E = VPM straight connector, tube Ø10 mm (L) F = VPM straight connector, tube Ø12 mm (L) B = VPG straight connector, tube Ø6 mm (S) C = VPG straight connector, tube Ø8 mm (L) E = VPG straight connector, tube Ø10 mm (L) F = VPG straight connector, tube Ø12 mm (L)									
<b>Sections</b>									

... = to be configured in the section configurator below

<b>Section configurator <sup>4)</sup></b>	-	-
<b>Section (minimum 3 sections)</b>		
<b>Single</b>	<b>Twin</b>	
D = 0,20 cm <sup>3</sup> /cycle F = 0,40 cm <sup>3</sup> /cycle H = 0,60 cm <sup>3</sup> /cycle K = 0,80 cm <sup>3</sup> /cycle M = 1,00 cm <sup>3</sup> /cycle Q = 1,20 cm <sup>3</sup> /cycle	C = 0,10 cm <sup>3</sup> /cycle E = 0,20 cm <sup>3</sup> /cycle G = 0,30 cm <sup>3</sup> /cycle J = 0,40 cm <sup>3</sup> /cycle L = 0,50 cm <sup>3</sup> /cycle N = 0,60 cm <sup>3</sup> /cycle	
<b>Outlet connector left</b>		
S = outlet closed by screw plug <sup>5)</sup> X = outlet without fitting		
<b>Outlet connector right</b>		
S = outlet closed by screw plug <sup>5)</sup> X = outlet without fitting		

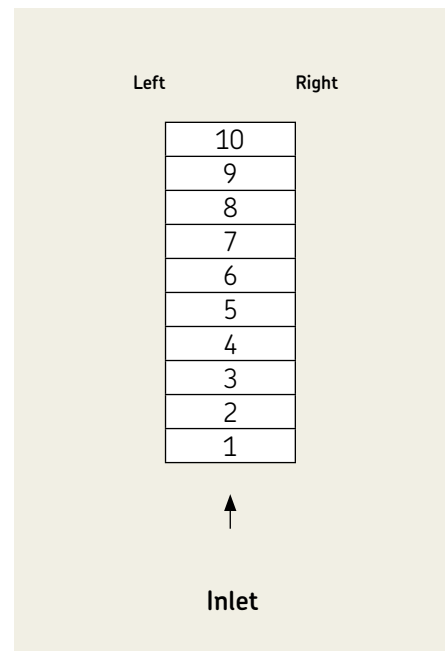

<sup>1)</sup> The installation of the cycle indicator is only possible from metering device section 2T and 2S, respectively!  
<sup>2)</sup> Solderless pipe unions with cutting sleeve acc. to DIN 2353  
<sup>3)</sup> LL-series = extra light version, L-series = light version, S-series = heavy-duty version  
<sup>4)</sup> Repeat this entry according to number of selected sections (1 to 10)  
<sup>5)</sup> Metering device only operates with one side (left or right) outlet closed per section





## Overview of oil circulation control units and software

Control units						
Product	Function type	Operating temperature max.		Electrical connection		Page
		°C	°F	V DC	V AC	
<b>ST-2240-CIRC</b>	Control unit	-20 to +70	-4 to +158	-	93–132 / 5.4 A 186–264 / 2.2 A	90
<b>PGA 3</b>	Programming and display unit	-20 to +70	-4 to +158	24/170 mA	-	91

Control and monitoring software				
Product	Function type	Metering device to be used with	Connection interface	Page
<b>SKF Flowline Software</b>	Software	SKF Flowline Monitor flow meters	USB or SKF Flowline HUB (LAN)	92
<b>SKF Variolub Software</b>	Software	IPM 12 pulse meter	USB	93

## Control unit

## ST-2240 CIRC



## Description

The SKF Control Centre ST-2240-CIRC is a stand-alone controller for oil circulation lubrication systems. It comes with a touch screen and remote smart phone option. It is a flexible and cost-effective solution for controlling and monitoring oil circulation lubrication systems. It comes with an easy-to-use touch screen interface, machine interlocking and various communication protocol.

## Features and benefits

- Automatic and manual pump change
- Control of output pressure, output oil temperature and oil reservoir heating and filter pressures
- Automatic cold start-up mode
- By-pass valve control

## Applications

- Pulp and Paper, metals industry
- Mining, mineral processing and cement
- Power plants

## Technical data

Function	control unit
Operating temperature 1)	-20 to +70 °C; -4 to +158 °F
Power supply	93–132 VAC / 5.4 A 186–264 VAC / 2.2 A 47–63 Hz
Instrument power supply	Internal power supply 24 V DC / 10A
Display	5.7 TFT touch screen, 64k color
Ports	Ethernet for remote control via web browser or mobile app for Android and iPhone/iPad USB for log and trend memory Modbus TCP for DCS (data control system) interface
Control unit	SKF ST-105
Communication	2 Modbus ports for VFD and display communication RS232/CAN interface for Flowline monitor communication
Input	4 analog/digital 4...20 A 6 digital 10 mA
Output	8 digital 24V / 2A 2 relay outputs for alarm and interlocking
Protection class	IP 65
Dimensions	380 × 380 × 210 mm 14.96 × 14.96 × 8.27 in
Mounting position	vertical

## ST-2240

Order number	Designation
12380707	ST-2240-CIRC
on request	ST-2240-SUMP
on request	power stack for ST-2240-CIRC



## NOTE

Further technical information, technical drawings, accessories, spare parts or product function descriptions available on [SKF.com/lubrication](http://SKF.com/lubrication):

**14257 EN**

## Programming and display unit

### PGA 3



#### Description

The PGA 3 programming and display unit is an input device for the IPM 12 pulse meter. It is used to parameterize the IPM 12 and display current flow rates of the IPM 12 connected to it. It can be used to transfer data to a customer data control system or a condition monitoring system via an OPC interface (Ethernet). The PGA 3 mobile version is used for maintenance purposes. Its function and design is identical.

#### Features and benefits

- Portable version available
- Easy handling
- Easy-to-read display
- Interface to condition monitoring system
- Interface to customer data control system (DCS)

#### Applications

- Pulp and paper industry
- Metals industry
- Automobile body presses
- Machine tools

#### Technical data

Function	programming and display unit
Operating temperature <sup>1)</sup>	-20 to +70 °C; -4 to +158 °F
Operating voltage	24 V DC
Power consumption	170 mA
Interfaces	ethernet LAN interface RS 232 / 422 / 485, serial interface
Indicating range	1 – 9999 pulse/min or 0,01 – 99 l/min; 0,00 – 26.15 gal/min
Display	approx. 62 × 44 mm; 2.44 × 1.73 in
Display precision	± 2%
Protection class	IP 65
Dimensions	with housing: 191 × 161 × 57 mm; 75.3 × 6.34 × 2.24 in
Mounting position	any

#### PGA 3

Order number	Designation
<b>84-8011-0402</b>	PGA 3 mobile including connection cable
<b>84-8011-0401</b>	PGA 3 mobile
<b>84-8011-0400</b>	PGA 3 stationary
<b>24-6882-5010</b>	Connection cable for PGA 3 mobile



#### NOTE

Further technical information, technical drawings, accessories, spare parts or product function descriptions available on [SKF.com/lubrication](http://SKF.com/lubrication):

**1-3022-EN; 951-180-003 EN**



## Software

# SKF Flowline Software



## Description

The SKF Flowline Software is designed as a stand alone monitoring software for SKF Flowline Monitor flow meters. It collects and processes information on current states of all connected flow meters and records trends. A detailed visualization enables the operator to track down each alarm signal from the factory view to the individual panel and flow meter. The software provides detailed information on each lubrication point.

## Features and benefits

- Full overview of all connected flow meters
- Traceability down to the lubrication point
- Compatibility with Canbus, Modbus, Profibus, Profinet

## Applications

- Pulp and paper industry
- Metals industry
- Mining, mineral processing and cement

### SKF Flowline Software

Order number	Designation
13399500	Flowline Software Version 2 with Flowline Hub
13399510	Flowline Software Version 2 with Flowline Hub and Bus Gateway
13399520	Flowline Software Version 2 with USB interface
13399540	Flowline Software Version 2 with Ethernet interface
13399560	Flowline Software Version 2 with RS232 interface



# SKF Variolub Software



## Description

The SKF Variolub Software offers an inexpensive solution for the set-up of the IPM 12 pulse meter. It can be downloaded to a laptop computer for maintenance purposes in the field and directly communicates with the IPM 12 connected to it. Set points can be defined for each individual lube point whereas the alarm limits are set as a common parameter for each IPM 12. Inputs currently not in use can be switched off.

## Features and benefits

- Human Machine Interface for parameter setting
- Connector cable to connect a laptop computer (Sub-D9) to the IPM 12 pulse meter (M12)
- Adaptor Sub-D9 – USB optional

## Applications

- Pulp and paper industry
- Metals industry
- Automobile body presses

### SKF Variolub Software

Order number	Designation
<b>84-8013-0001</b>	Software IPM 12V1.01
<b>24-6882-5003</b>	Connection cable laptop RS 232
<b>44-2392-2694</b>	USB RS 232 adapter



## Overview of oil circulation monitoring devices

### Level switches

Product	Function type	Operating temperature max.		Electrical connection		Page
		°C	°F	V DC	V AC	
<b>WS 32/33/35</b>	level switch	-10 to +80	+14 to 175	230	230	96
<b>WS-63-2</b>	level switch	-10 to +80	+14 to 175	200	240	98
<b>WS 68</b>	level switch	-10 to +80	+14 to 175	48	48	98

### Monitoring and indication devices

Product	Function type	Operating temperature max.		Electrical connection		Page
		°C	°F	V DC	V AC	
<b>171-210</b>	flow monitor	+5 to 80	+41 to 176	-	250 / 0,5 A	100
<b>IPM 12</b>	pulse meter	0 to +70	+32 to 158	24 ±15%; 0,15 A	-	102
<b>SFZ</b>	gear wheel indicator hall sensor	0 to +70	+32 to 158	24 ±10%; 20 mA	-	104

## Level switch

## WS 32/33/35



## Description

Fill level switches monitor the fill level in non-pressurized fluid reservoirs. To meet different requirements, fill level switches either have one or two switching points. If fill level switches have one switching point (WS32), the minimum fill level in the reservoir is monitored. Fill level switches with two switching points either monitor the minimum and maximum fill levels in the reservoir so the filling stops automatically when the maximum level is reached (WS33), or they monitor the minimum fill level and have an early warning function (WS35). The latter version gives a signal before a critical oil level in the reservoir is reached so oil can be topped off before the machine stops working. Other fill level switches are available on request, e.g. with three switching points.

## Features and benefits

- Easy mounting
- Different plug sizes
- Various switching points

## Applications

- Machine tools
- Printing
- Automation

## Technical data

Function	level switch
Lubricant	mineral and synthetic oils; viscosity max. 1 500 mm <sup>2</sup> /s
Operating temperature	-10 to +80 °C; +14 to 175 °F
Material	Aluminium, CuZn, NBR, PP
Switching points :	
WS 32	1
WS 33, WS35	2
Switching element	reed contact
Switching voltage	230 V AC, 230 V DC
Switching capacity max.	60 VA / 40 W
Switching current max.	1 A
Switching point settings	100–1 600 mm; 3.94–63 in
Protection class	IP 65
Dimensions	
WS32	min. 100-1 600 × 52 × 52 mm min. 3.94-63 × 2 × 2 in
WS33	max. 120-600 × 52 × 52 mm max. 4.72-23.6 × 2 × 2 in
WS 35	max. 120-1 600 × 52 × 52 mm max. 4.72-63 × 2 × 2 in
Mounting position	vertical



## NOTE

Further technical information, technical drawings, accessories, spare parts or product function descriptions available on [SKF.com/lubrication](http://SKF.com/lubrication):

**1-1702-EN**

# Level switch

## WS 32/33/35

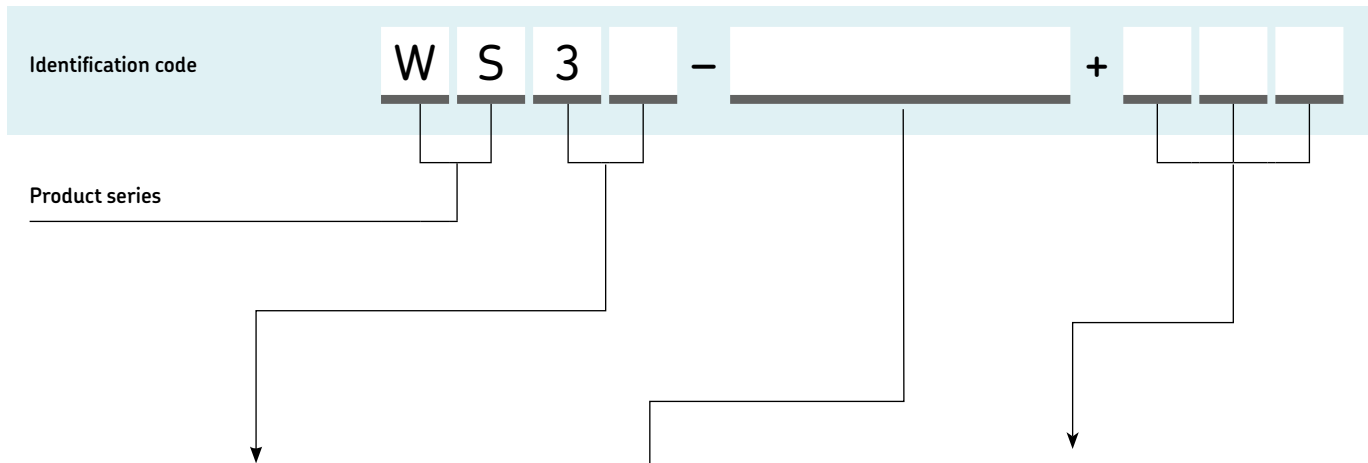

**Switching points <sup>1)</sup>**

Code	Designation
32	Minimum fill level
33	Minimum and maximum fill levels
35	Early warning and minimum fill level

<sup>1)</sup> gasket included

**Plug connector and visual monitoring**

Code	Designation
S10	Circular connector with cable socket and LED
2	Square connector with cable socket, without LED
S30	Circular connector M12x1 with LED
2-V57-A	Circular connector x1 without LED

**Lengths keys for fill level switch**

Lenght mm	Designation	Lengths keys					
		WS32	WS33	WS33	WS33	WS35	
		-	50	100	150	65	-
100	C49	-	-	-	-	-	-
110	C25	-	-	-	-	-	-
120	C17	V69	V69	-	-	-	C17
130	B27	Y72	Y72	-	-	-	B27
140	B97	X16	X16	-	-	-	B97
150	C08	X41	X41	Z06	-	-	C08
160	E08	X24	X24	-	-	-	E08
170	D84	X07	X07	-	-	-	D84
180	B53	X22	X22	-	-	-	B53
190	E77	Y91	Y91	-	-	-	E77
200	B31	V85	V85	Y87	-	-	B31
210	D42	ZE7	ZE7	-	-	-	D42
220	C52	V86	V86	-	-	-	C52
230	C81	V27	V27	-	-	-	C81
240	C79	Z49	Z49	-	-	-	C79
250	B44	X46	X46	V23	ZG4	-	B44
260	F01	Y69	Y69	-	-	-	F01
270	D54	ZL8	ZL8	-	-	-	D54
280	C04	X98	X98	-	-	-	C04
290	D65	X84	X84	-	-	-	D65
300	B37	X76	X76	V75	-	-	B37
325	E28	-	-	-	-	-	E28
350	B46	X86	X86	V21	-	-	B46
375	D13	-	-	-	-	-	D13
400	B95	V74	V74	V43	-	-	B95
425	D56	-	-	-	-	-	D56
450	L69	Y85	Y85	-	-	-	L69
475	E30	-	-	-	-	-	E30
500	B28	V49	V49	V17	Y77	-	B28
550	B48	-	-	-	-	-	B48
600	B51	-	-	X93	-	-	B51
650	C65	-	-	-	-	-	C65
700	F94	-	-	-	-	-	F94
750	E54	-	-	-	-	-	E54
800	F29	-	-	-	-	-	F29
850	F53	-	-	-	-	-	F53
900	L24	-	-	-	-	-	L24
1 000	B70	-	-	-	-	-	B70
1 100	B84	-	-	-	-	-	B84
1 200	F49	-	-	-	-	-	F49
1 300	F77	-	-	-	-	-	F77
1 400	L06	-	-	-	-	-	L06
1 500	F83	-	-	-	-	-	F83
1 600	L34	-	-	-	-	-	L34



## Level switch

## WS63-2



## Description

Fill level switches monitor the fill level in non-pressurized fluid reservoirs. To suit different requirements, the fill level switches either have one or two switching points. WS63-2 series has only one switching point and electric contact opens with dropping oil level. The switch can be turned by 180° to make the electric contacts close with rising oil level.

## Features and benefits

- Compact design
- Dropping and rising oil level monitoring

## Applications

- Machine tools
- Printing
- Automation

## Technical data

Order number	<b>WS63-2</b>
Function	level switch
Lubricant	mineral and synthetic oils; viscosity max. 1 500 mm <sup>2</sup> /s
Operating temperature	-10 to +80 °C; +14 to 175 °F
Material	PP, Aluminium, NBR
Switching voltage	240 V AC, 200 V DC
Switching capacity max.	100 VA / 50 W
Switching current max.	0,5 A
Switching points	1
Protection class	IP 65
Dimensions	55 × 55 × 131 mm 2.17 × 2.17 × 5.16 in
Mounting position	horizontal

**NOTE**

Further technical information, technical drawings, accessories, spare parts or product function descriptions available on [SKF.com/lubrication](http://SKF.com/lubrication):

**1-1702-EN**

## Level switch

# WS68



### Description

Fill level switches monitor the fill level in non-pressurized fluid reservoirs. To suit different requirements, the fill level switches either have one or two switching points. WS 68 series has only one switching point, and electric contact opens with dropping oil level.

### Features and benefits

- Compact design
- Dropping and rising oil level monitoring

### Applications

- Machine tools
- Printing
- Automation

### Technical data

Order number	<b>WS68</b>
Function	level switch
Lubricant	mineral and synthetic oils; viscosity max. 1 500 mm <sup>2</sup> /s
Operating temperature	-10 to +80 °C; +14 to 175 °F
Material	NBR, Aluminium, PA
Switching voltage	48 V AC/DC
Switching capacity max.	10 VA / 10 W
Switching current max.	0,25 A
Switching points	1
Protection class	IP 65
Dimensions	53 × 53 × 62 mm 2.09 × 2.09 × 2.44 in
Mounting position	horizontal



### NOTE

Further technical information, technical drawings, accessories, spare parts or product function descriptions available on [SKF.com/lubrication](http://SKF.com/lubrication):

**1-1702-EN**

## Flow monitor

171-210



## Description

Flow monitors are minimum flow detector switches. They represent an inexpensive solution for the monitoring of smaller oil circulation lubrication systems or critical lubrication points in systems that generally are not equipped with individual flow monitoring.

## Features and benefits

- Effective monitoring of minimum oil flow
- Wide flow range
- Available in five ranges but with identical outer dimensions
- High operating temperature

## Applications

- Automotive industry
- Metal forming
- Machine tools
- Heavy industry

## Technical data

Function	Flow switch
Lubricant	mineral oils; viscosity 20–1 000 mm <sup>2</sup> /s <sup>1)</sup>
Flow rate	0,05–14 l/min; 0.013–3.70 gal/min
Operating temperature	+5 to 80 °C; +41 to 176 °F
Operating pressure <sup>1)</sup>	4–25 bar; 58–363 psi
Electrical connection	change-over 250 V AC / 0,5 A
Inlet connection	depending on model: M10×1, M18×1,5 M18×1,5
Outlet connection	
Material:	die-cast zinc, polyamide
Housing	NBR (FKM on request)
Seals	IP 65
Protection class	min. 90 × 47 × 34 mm
Dimensions	max. 101 × 47 × 34 mm min. 3.54 × 1.85 × 1.33 in max. 3.98 × 1.85 × 1.33 in
Mounting position	any

<sup>1)</sup> If the flow monitors are equipped with metering restrictors, at least 6 bars are required in the feed line

 NOTE

Further technical information, technical drawings, accessories, spare parts or product function descriptions available on [SKF.com/lubrication](http://SKF.com/lubrication):

**1-1704-EN, 951-170-232**



3D

[skf-lubrication.partcommunity.com/3d-cad-models](http://skf-lubrication.partcommunity.com/3d-cad-models)

## Flow monitor

## 171-210

## Flow monitor 171-210-05...

Order number	Flow rate		Connection	
	l/min	gal/min	inlet	outlet
<b>171-210-051</b>	0,05–0,1	0.01–0.03	M10×1	M18×1,5
<b>171-210-052</b>	0,1–0,2	0.03–0.05	M10×1	M18×1,5
<b>171-210-053</b>	0,2–0,5	0.05–0.13	M10×1	M18×1,5
<b>171-210-054</b>	0,5–0,8	0.13–0.21	M10×1	M18×1,5
<b>171-210-055</b>	0,8–1,8	0.21–0.48	M10×1	M18×1,5

## Flow monitor 171-210-06...

Order number	Flow rate		Connection	
	l/min	gal/min	inlet	outlet
<b>171-210-061</b>	1,6–2,5	0.42–0.67	M18×1,5	M18×1,5
<b>171-210-062</b>	2,3–4,0	0.61–1.06	M18×1,5	M18×1,5
<b>171-210-063</b>	3,6–6,0	0.95–1.59	M18×1,5	M18×1,5
<b>171-210-064</b>	5,5–10,0	1.45–2.64	M18×1,5	M18×1,5
<b>171-210-065</b>	8,0–14,0	2.11–3.70	M18×1,5	M18×1,5

Connection fittings for 171-210-05... <sup>1)</sup>

Inlet connection	Tube Ø	Union nut	Cutting ring	Adapter	Washer
mm					
M10×1	6	406-302	406-301	GD60.02	504-019
M10×1	8	408-302	408-301	GD80.02	-
M10×1	10	410-302	410-301	GD100.02	-

Connection fittings for 171-210-06... <sup>1)</sup>

Inlet connection	Tube Ø	Functional nut
mm		
M18×1,5	12	460-212-001

Connection fittings <sup>1)</sup>

Outlet connection	Tube Ø	Adapter
mm		
M18×1,5	6	473-806-391
M18×1,5	8	473-808-392
M18×1,5	10	473-810-391

<sup>1)</sup> Port tapped for solderless cutting-sleeve screw union to DIN 2353, connection piece without restrictor, straight screw-in connector

## Pulse meter

## IPM 12



## Description

The IPM 12 pulse meter is used to monitor the functionality of oil circulation metering devices like restrictor valve metering devices, flow limiters or progressive metering devices. It allows for the monitoring of as many as 12 lubrication points per pulse meter, each point being assigned to one input of the IPM 12. Thanks to its modular design, the IPM 12 easily can be adapted to machines and systems at any time. Based on specified values entered via a programming unit or programming software, each lubrication point is monitored individually with LEDs indicating in the event of malfunctions or alarms. Also, relay contacts signal alarms to the process control level.

## Features and benefits

- Easy wiring and installation
- Modular design for simple system extension
- RS 232 interface
- Easy parameter set-up

## Applications

- Pulp and paper industry
- Metals industry
- Automobile body presses

## Technical data

Function	pulse meter
Operating temperature	0 to +70 °C; +32 to 158 °F
Connection type	screw terminal 1,5 mm <sup>2</sup>
Electrical data	
Operating voltage	24 V DC ±15%
Power consumption	0,15 A
Interface	RS 232
Transmission rate	9 600 baud
Signal amplitude	± 9 V
Signal inputs	12 <sup>1)</sup> pulse generator inputs, min. pulse width 20 ms
Signal outputs	2 change-over switches (isolated)
Switching voltage	max. 250 V AC
Switching current	max. 2 A
Switching capacity	250 VA
Protection class	IP 64
Dimensions	200 × 120 × 93 mm 7.87 × 4.72 × 3.66 in
Mounting position	any
Options	PNP initiators, three-wire technology as per Namur, two-wire technology 24 V DC contactor, max. 15 mA

<sup>1)</sup> The start-up mode and the external reset signals require free inputs. In case these signals are used, the number of pulse inputs is reduced accordingly.



## NOTE

Further technical information, technical drawings, accessories, spare parts or product function descriptions available on [SKF.com/lubrication](http://SKF.com/lubrication):

**1-3022-EN; 951-180-003 EN**



## Pulse meter

# IPM 12

### IPM 12

for the use with Variolub, SMB 9, 10, 13, 14

Order number	Designation
<b>84-8011-0380</b>	IPM 12 pulse meter without connection socket for PGA 3 mobile
<b>84-8011-0390</b>	IPM 12 pulse meter with connection socket for PGA 3 mobile

### IPM 12

for the use with SMB 3, 6, 8

Order number	Designation
<b>84-8011-0369</b>	group monitoring unit

### IPM 12 accessories

Order number	Designation
<b>24-6882-5002</b>	connection socket for PGA 3
<b>24-6882-5010</b>	connection cable for PGA 3

## Gear wheel indicator

# SFZ



### Description

The SFZ product series offers robust flow monitoring even under harsh environmental conditions. Its gear-wheel measuring principle is based on the flow limiter technology.

### Features and benefits

- Three designs with metering ranges from 0 to 180 l/min (0 to 380 pts/min)
- Robust aluminium body
- Sight glass for visual monitoring
- Gear-wheel-type measuring principle

### Applications

- Pulp and paper industry
- Metals industry
- Mining
- Mineral processing
- Cement
- Automobile body presses

### Technical data

Function	gear wheel indicator
Lubricant	mineral and synthetic oils; viscosity 20–600 mm <sup>2</sup> /s
Operating temperature <sup>1)</sup>	0 to +70 °C; +32 to 158 °F
Operating pressure	6–50 bar 87–725 psi
Flow rate	
SFZ 9/6/1; SFZ 9E/6/1:	0,09–8,2 l/min; 0,19–17,3 pts/min
SFZ 9E30/1:	6–30 l/min; 12,7–63,4 pts/min
SFZ 9E100/1:	25–132 l/min; 52,8–279 pts/min
SFZ 9E180/3:	max. 180 l/min; max. 380 pts/min
Electrical connection	hall sensor
Voltage	24 VDC ±10%; 20mA
Material	Al, Cu, Mg, Pb
Protection class	IP 65
Dimensions	min. 80 × 80 × 75 mm max. 190 × 180 × 150 mm min. 3.1 × 3.1 × 3.0 in max. 190 × 180 × 150 in
Mounting position	any

## Gear wheel indicator

# SFZ

SFZ						
Order number	Designation	Monitoring	Connection	Flow rate		
				l/min	pts/min	
24-2581-2150	SFZ 9/6/1	visual	G 3/8	0,09–8,2	0.19–17.3	
24-2581-2151	SFZ 9E/6/1	electrical	G 3/8	0,09–8,2	0.19–17.3	
24-2581-2155	SFZ 9E30/1	electrical	G 3/4	6–30	12.7–63.4	
24-2581-2156	SFZ 9E100/1	electrical	G 1 1/4	25–132	52.8–279	
24-2581-2550	SFZ 9E180/3	electrical	G 1 1/4	max. 180	max. 380	



## Overview of oil circulation system accessories

Filters							
Product	Function type	Operating temperature max.		Filter rating	Operating pressure max.		Page
		°C	°F		bar	psi	
<b>169-460-...</b>	oil filter	-30 to +100	-22 to 212	3-50	100	1450	108
<b>169-400-...</b>	filter elements	-30 to +100	-22 to 212	3-50	30	435	108
<b>176-200-...</b>	dirt indicators	-30 to +100	-22 to 212	3-50	-	-	108



## Filter

## 169-460-...



## Description

SKF pressure filter series 169-460 are standard oil filters according to DIN 24550. They are modular in design with a filter housing (filter head/ filter body), a filter element and a screw plug. Optionally a dirt indicator can be selected instead of the screw plug. The pressure filters are used as line filters in the pipes of the CircOil lubrication system for separating solids from the fluids. Two kinds of filter elements are available. Fiberglass fleece – disposable elements based on inorganic fibers (absolute filtration) or wire fabric (nominal filtration). The dirt indicator monitors the filter element and signals when it needs to be replaced.

## Features and benefits

- Prevents system or component failures and extends system life due to significant reduction of solids
- Economical, reliable and maintenance-friendly operation
- Compact and modular design mountable directly into pipes
- Wide range of volumetric flow up levels and grades of filtration
- Optimized service handling by replacing of filter elements only
- Dirt monitoring of filter elements as an option

## Applications

- General mechanical and plant engineering
- Shipbuilding and offshore industry
- Pulp and paper industry
- Heavy industry

## Technical data

Function	oil filter
Lubricant	mineral and synthetic oils; viscosity 20–1 000 mm <sup>2</sup> /s
Operating temperature	-30 to +100 °C; -22 to 212 °F
Operating pressure	max. 100 bar max. 1450 psi
Pressure difference:	
Fiberglass fleece	Δp 30 bar; 435 psi
Dirt indicators	Δp 5 bar; 72.5 psi
Collapse pressure resistance:	
Fiberglass fleece	20 bar; 290 psi
Wire fabric	30 bar; 435 psi
Volumetric flow up	40 l, 63 l, 100 l; 10.6, 16.6, 26.4 gal
Filter ratings	3 to 50 μm
Material:	
Housing	Aluminum
Sealing material	FKM
Filter	Fiberglass fleece-inorganic-absolute filtration, wire fabric-stainless steel-nominal filtration
Connecting thread (ISO 228)	G 1/2
Dimensions	min. 92 × 82 × 186 mm max. 92 × 82 × 426 mm min. 3.62 × 3.3 × 7.32 in max. 3.62 × 3.3 × 16.77 in
Mounting position	vertical



## NOTE

Further technical information, technical drawings, accessories, spare parts or product function descriptions available on [SKF.com/lubrication](http://SKF.com/lubrication):

**1-0116-EN; 1-0103-EN; 995-901-056 EN**

# Filter

## 169-460-...

Filter complete	Volumetric flow		Filter element	Filter rating	Dirt retention		Filter material	Dirt indicator, display	Housing
	l	gal			µm	g			
<b>169-460-261</b>	40	10.6	<b>169-400-260-V57</b>	3	5,2	-	Fiberglass fleece	<b>176-200-012</b>	<b>853-880-011</b>
<b>169-460-269</b>	40	10.6	<b>169-400-260-V57</b>	3	5,2	-	Fiberglass fleece	<b>833-030-014</b>	<b>853-880-011</b>
<b>169-460-273</b>	40	10.6	<b>169-400-260-V57</b>	3	5,2	-	Fiberglass fleece	<b>176-200-013</b>	<b>853-880-011</b>
<b>169-460-279</b>	40	10.6	<b>169-400-260-V57</b>	3	5,2	-	Fiberglass fleece	<b>176-200-014</b>	<b>853-880-011</b>
<b>169-460-280</b>	40	10.6	<b>169-400-260-V57</b>	3	5,2	-	Fiberglass fleece	<b>176-200-011</b>	<b>853-880-011</b>
<b>169-460-262</b>	40	10.6	<b>169-400-250</b>	10	6,3	-	Fiberglass fleece	<b>176-200-012</b>	<b>853-880-011</b>
<b>169-460-264</b>	63	16.6	<b>169-400-252</b>	10	11,3	-	Fiberglass fleece	<b>176-200-012</b>	<b>853-880-012</b>
<b>169-460-266</b>	100	26.4	<b>169-400-254</b>	10	18,6	-	Fiberglass fleece	<b>176-200-012</b>	<b>853-880-013</b>
<b>169-460-270</b>	40	10.6	<b>169-400-250</b>	10	6,3	-	Fiberglass fleece	<b>176-200-014</b>	<b>853-880-011</b>
<b>169-460-274</b>	40	10.6	<b>169-400-250</b>	10	6,3	-	Fiberglass fleece	<b>176-200-013</b>	<b>853-880-011</b>
<b>169-460-287</b>	40	10.6	<b>169-400-252</b>	10	11,1	-	Fiberglass fleece	<b>176-200-014</b>	<b>853-880-012</b>
<b>169-460-286</b>	63	16.6	<b>169-400-286</b>	20	-	-	Fiberglass fleece	<b>176-200-013</b>	<b>853-880-012</b>
<b>169-460-263</b>	40	10.6	<b>169-400-255</b>	25	7	-	Fiberglass fleece	<b>176-200-012</b>	<b>853-880-011</b>
<b>169-460-265</b>	63	16.6	<b>169-400-253</b>	25	12,8	-	Fiberglass fleece	<b>176-200-012</b>	<b>853-880-012</b>
<b>169-460-267</b>	100	26.4	<b>169-400-256</b>	25	20,6	-	Fiberglass fleece	<b>176-200-012</b>	<b>853-880-012</b>
<b>169-460-271</b>	40	10.6	<b>169-400-255</b>	25	7	-	Fiberglass fleece	<b>833-030-014</b>	<b>853-880-011</b>
<b>169-460-276</b>	40	10.6	<b>169-400-255</b>	25	7	-	Fiberglass fleece	<b>176-200-010</b>	<b>853-880-011</b>
<b>169-460-278</b>	40	10.6	<b>169-400-255</b>	25	7	-	Fiberglass fleece	<b>176-200-013</b>	<b>853-880-011</b>
<b>169-460-288</b>	63	16.6	<b>169-400-253</b>	25	12,8	-	Fiberglass fleece	<b>176-200-010</b>	<b>853-880-012</b>
<b>169-460-284</b>	40	10.6	<b>169-400-185-V57</b>	25	-	440	Wire fabric	<b>176-200-014</b>	<b>853-880-011</b>
<b>169-460-259</b>	40	10.6	<b>169-400-251</b>	50	-	440	Wire fabric	<b>833-030-014</b>	<b>853-880-011</b>
<b>169-460-272</b>	40	10.6	<b>169-400-251</b>	50	-	440	Wire fabric	<b>176-200-013</b>	<b>853-880-011</b>
<b>169-460-282</b>	40	10.6	<b>169-400-251</b>	50	-	440	Wire fabric	<b>176-200-009</b>	<b>853-880-011</b>

Dirt indicators				
Order number	Indication	Switching type	Electrical connections	Switching points
<b>176-200-009</b>	Electrical/Optical	1x NO-contact / 1x NC-contact	M12x1 / 4-pin	75% / 100%
<b>176-200-010</b>	Electrical/Optical	1x NO-contact / 1x NC-contact	M12x1 / 4-pin / LED, Cold start suppression 30°C	75% / 100%
<b>176-200-011</b>	Electrical/Optical	2x NC-contact	-	75% / 100%
<b>176-200-012</b>	Electrical/Optical	1x NO-contact / 1x NC-contact	-	75% / 100%
<b>176-200-013</b>	Optical	-	-	-
<b>176-200-014</b>	Electrical	Change-over contact	DIN EN 175301-803-A	-

Filter elements	
Order number	Designation
<b>169-400-260-V57</b>	3 µm; NG 40
<b>169-400-257</b>	3 µm; NG 63
<b>169-400-250</b>	10 µm; NG 40
<b>169-400-252</b>	10 µm; NG 63
<b>169-400-254</b>	10 µm; NG 100
<b>169-400-286</b>	20 µm; NG 63
<b>169-400-185-V57</b>	25 µm; NG 40
<b>169-400-253</b>	25 µm; NG 63
<b>169-400-255</b>	25 µm; NG 40
<b>169-400-256</b>	25 µm; NG 100
<b>169-400-251</b>	50 µm; NG 40

Filter accessories	
Order number	Designation
<b>833-030-014</b>	Closure plug
<b>853-880-011</b>	Filter housing, without reverse flow rate NG 40
<b>853-880-012</b>	Filter housing, without reverse flow rate NG 63
<b>853-880-013</b>	Filter housing, without reverse flow rate NG 100
<b>881-280-050</b>	Mounting bracket for 3-liter plastic and metal reservoir
<b>881-280-044</b>	Retaining plate for 6-liter plastic reservoir
<b>881-290-270</b>	Filter plate for 6-liter metal reservoir
<b>881-290-271</b>	Filter plate for 15-liter metal reservoir
<b>881-290-272</b>	Filter plate for 30-liter metal reservoir
<b>881-290-273</b>	Filter plate for 50-liter metal reservoir

# Index

24-0404-2117.....	66	24-0714-3185.....	70	24-1072-2115.....	67
24-0404-2117.....	71	24-0714-3186.....	70	24-1254-2486.....	75
24-0404-2119.....	61	24-0714-3231.....	74	24-1254-2487.....	75
24-0404-2155.....	63	24-0714-3232.....	74	24-1503-2102.....	55
24-0404-2281.....	75	24-0714-3234.....	74	24-1503-2103.....	55
24-0404-2293.....	66	24-0714-3236.....	74	24-1503-2104.....	55
24-0404-2293.....	70	24-0714-3241.....	74	24-1874-2104.....	71
24-0404-2293.....	75	24-0714-3242.....	74	24-1874-2106.....	66
24-0404-2310.....	77	24-0714-3244.....	74	24-1882-2029.....	77
24-0404-2311.....	79	24-0714-3246.....	74	24-1882-2029.....	79
24-0404-2339.....	66	24-0714-3261.....	74	24-1882-2121.....	61
24-0404-2340.....	71	24-0714-3262.....	74	24-1882-2121.....	63
24-0404-2341.....	75	24-0714-3263.....	74	24-1882-2121.....	67
24-0404-2520.....	55	24-0714-3264.....	74	24-1882-2151.....	61
24-0404-2520.....	55	24-0714-3265.....	74	24-1882-2151.....	63
24-0404-2521.....	55	24-0714-3266.....	74	24-1882-2151.....	67
24-0404-2521.....	55	24-0714-3470.....	66	24-1883-2081.....	61
24-0651-2200.....	66	24-0714-3471.....	66	24-1883-2093.....	75
24-0651-2200.....	70	24-0714-3472.....	66	24-1883-3005.....	66
24-0651-2200.....	75	24-0714-3473.....	66	24-1883-3010.....	71
24-0651-3041.....	66	24-0714-3474.....	66	24-1883-3012.....	71
24-0651-3041.....	70	24-0714-3475.....	66	24-1883-3016.....	77
24-0651-3041.....	75	24-0714-3476.....	66	24-1883-3017.....	79
24-0711-2403.....	66	24-0714-3477.....	66	24-1883-3020.....	75
24-0711-2403.....	66	24-0714-3478.....	66	24-1884-2282.....	61
24-0711-2405.....	71	24-0714-3479.....	66	24-1884-2282.....	63
24-0711-2406.....	75	24-0714-3480.....	66	24-1884-2282.....	67
24-0712-6050.....	63	24-0714-3481.....	66	24-2104-2009.....	66
24-0714-3164.....	74	24-0714-3482.....	66	24-2104-2009.....	70
24-0714-3164.....	74	24-0758-2113.....	75	24-2104-2009.....	75
24-0714-3171.....	70	24-1072-2113.....	61	24-2151-3734.....	84
24-0714-3172.....	70	24-1072-2113.....	61	24-2151-3736.....	84
24-0714-3173.....	70	24-1072-2113.....	63	24-2151-3760.....	80
24-0714-3174.....	70	24-1072-2113.....	63	24-2151-3760.....	82
24-0714-3175.....	70	24-1072-2113.....	67	24-2151-3762.....	80
24-0714-3176.....	70	24-1072-2113.....	67	24-2151-3762.....	82
24-0714-3180.....	71	24-1072-2114.....	61	24-2151-3764.....	80
24-0714-3181.....	70	24-1072-2114.....	63	24-2151-3764.....	82
24-0714-3182.....	70	24-1072-2114.....	67	24-2581-2150.....	105
24-0714-3183.....	70	24-1072-2115.....	61	24-2581-2151.....	105
24-0714-3184.....	70	24-1072-2115.....	63	24-2581-2155.....	105

# Index

24-2581-2156.....	105	44-0758-2049.....	77	169-400-253.....	109
24-2581-2550.....	105	44-0758-2049.....	79	169-400-254.....	109
24-2581-2615.....	55	44-2392-2694.....	93	169-400-254.....	109
24-2581-2616.....	55	84-8011-0369.....	61	169-400-255.....	109
24-2581-2617.....	55	84-8011-0369.....	63	169-400-255.....	109
24-2581-2650.....	55	84-8011-0369.....	67	169-400-255.....	109
24-2581-2651.....	55	84-8011-0369.....	103	169-400-255.....	109
24-2581-2652.....	55	84-8011-0380.....	71	169-400-255.....	109
24-2581-2656.....	55	84-8011-0380.....	75	169-400-256.....	109
24-2581-2657.....	55	84-8011-0380.....	77	169-400-256.....	109
24-2581-2658.....	55	84-8011-0380.....	79	169-400-257.....	109
24-2581-2693.....	55	84-8011-0380.....	103	169-400-260-V57.....	109
24-6882-5002.....	103	84-8011-0390.....	71	169-400-260-V57.....	109
24-6882-5003.....	93	84-8011-0390.....	75	169-400-260-V57.....	109
24-6882-5010.....	91	84-8011-0390.....	77	169-400-260-V57.....	109
24-6882-5010.....	103	84-8011-0390.....	79	169-400-260-V57.....	109
24-9909-0178.....	55	84-8011-0390.....	103	169-400-260-V57.....	109
24-9909-0178.....	55	84-8011-0400.....	91	169-400-286.....	109
24-9909-0179.....	55	84-8011-0401.....	91	169-400-286.....	109
24-9909-0179.....	55	84-8011-0402.....	91	169-460-259.....	109
24-9909-0184.....	55	84-8013-0001.....	93	169-460-261.....	109
24-9909-0184.....	55	95-0034-0908.....	55	169-460-262.....	109
44-0455-2357.....	79	95-0038-0908.....	71	169-460-263.....	109
44-0455-2360.....	79	95-2721-7603.....	55	169-460-264.....	109
44-0455-2363.....	79	161-218-000.....	35	169-460-265.....	109
44-0455-2365.....	79	161-228-051.....	35	169-460-266.....	109
44-0455-2367.....	79	169-400-185-V57.....	109	169-460-267.....	109
44-0455-2369.....	79	169-400-185-V57.....	109	169-460-269.....	109
44-0455-2371.....	79	169-400-250.....	109	169-460-270.....	109
44-0455-2373.....	79	169-400-250.....	109	169-460-271.....	109
44-0455-2374.....	79	169-400-250.....	109	169-460-272.....	109
44-0455-2375.....	79	169-400-250.....	109	169-460-273.....	109
44-0455-2376.....	79	169-400-251.....	109	169-460-274.....	109
44-0455-2377.....	79	169-400-251.....	109	169-460-276.....	109
44-0455-2378.....	79	169-400-251.....	109	169-460-278.....	109
44-0455-2379.....	79	169-400-251.....	109	169-460-279.....	109
44-0455-2380.....	79	169-400-252.....	109	169-460-280.....	109
44-0455-2381.....	79	169-400-252.....	109	169-460-282.....	109
44-0455-2382.....	79	169-400-252.....	109	169-460-284.....	109
44-0455-2385.....	79	169-400-253.....	109	169-460-286.....	109
44-0455-2386.....	79	169-400-253.....	109	169-460-287.....	109

# Index

169-460-288 .....	109	179-990-372 .....	61	473-806-391 .....	101
171-210-051 .....	101	179-990-372 .....	63	473-808-392 .....	101
171-210-052 .....	101	179-990-372 .....	67	473-810-391 .....	101
171-210-053 .....	101	179-990-600 .....	61	504-019 .....	101
171-210-054 .....	101	179-990-600 .....	63	508-108 .....	84
171-210-055 .....	101	179-990-600 .....	67	508-215-CU .....	53
171-210-061 .....	101	179-990-601 .....	61	605-27545-1 .....	43
171-210-062 .....	101	179-990-601 .....	63	605-27546-1 .....	43
171-210-063 .....	101	179-990-601 .....	67	605-27547-1 .....	43
171-210-064 .....	101	242-016.00 .....	53	605-27548-1 .....	43
171-210-065 .....	101	242-024.00 .....	53	605-28166-1 .....	43
176-200-009 .....	109	242-025.00 .....	53	833-030-014 .....	109
176-200-009 .....	109	242-026.00 .....	53	833-030-014 .....	109
176-200-010 .....	109	242-034.00 .....	53	833-030-014 .....	109
176-200-010 .....	109	242-035.00 .....	53	833-030-014 .....	109
176-200-010 .....	109	242-044.00 .....	53	853-880-011 .....	109
176-200-011 .....	109	242-045.00 .....	53	853-880-011 .....	109
176-200-011 .....	109	242-054.00 .....	53	853-880-011 .....	109
176-200-012 .....	109	242-055.00 .....	53	853-880-011 .....	109
176-200-012 .....	109	242-056.00 .....	53	853-880-011 .....	109
176-200-012 .....	109	242-064.00 .....	53	853-880-011 .....	109
176-200-012 .....	109	242-065.00 .....	53	853-880-011 .....	109
176-200-012 .....	109	242-104.00 .....	53	853-880-011 .....	109
176-200-012 .....	109	242-124.00 .....	53	853-880-011 .....	109
176-200-012 .....	109	242-146.00 .....	53	853-880-011 .....	109
176-200-012 .....	109	406-162 .....	53	853-880-011 .....	109
176-200-013 .....	109	406-301 .....	101	853-880-011 .....	109
176-200-013 .....	109	406-302 .....	101	853-880-011 .....	109
176-200-013 .....	109	408-162 .....	53	853-880-011 .....	109
176-200-013 .....	109	408-211 .....	53	853-880-011 .....	109
176-200-013 .....	109	408-301 .....	101	853-880-011 .....	109
176-200-013 .....	109	408-302 .....	101	853-880-011 .....	109
176-200-014 .....	109	410-018 .....	53	853-880-012 .....	109
176-200-014 .....	109	410-162 .....	53	853-880-012 .....	109
176-200-014 .....	109	410-301 .....	101	853-880-012 .....	109
176-200-014 .....	109	410-302 .....	101	853-880-012 .....	109
176-200-014 .....	109	412-011 .....	53	853-880-012 .....	109
179-990-033 .....	71	412-018 .....	53	853-880-012 .....	109
179-990-371 .....	61	460-212-001 .....	101	853-880-012 .....	109
179-990-371 .....	63	466-419-001 .....	80	853-880-013 .....	109
179-990-371 .....	67	466-419-001 .....	82	853-880-013 .....	109



# Index

881-280-044 .....	109	13120350.....	59	13143460.....	17
881-280-050 .....	109	13120352.....	59	13143461.....	17
881-290-270 .....	109	13120354.....	59	13143462.....	17
881-290-271.....	109	13120356.....	59	13143463.....	17
881-290-272.....	109	13120358.....	59	13143464.....	17
881-290-273 .....	109	13120360.....	59	13143465.....	17
12380707.....	90	13120362.....	59	13143466.....	17
13120180.....	59	13120364.....	59	13143470.....	17
13120182.....	59	13120366.....	59	13143471.....	17
13120202.....	59	13120368.....	59	13143472.....	17
13120204.....	59	13120370.....	59	13143473.....	17
13120206.....	59	13120372.....	59	13143474.....	17
13120208.....	59	13120374.....	59	13143475.....	17
13120210.....	59	13120376.....	59	13399500.....	92
13120212.....	59	13120378.....	59	13399510.....	92
13120214.....	59	13120380.....	59	13399520.....	92
13120216.....	59	13127800.....	59	13399540.....	92
13120218.....	59	13127802.....	59	13399560.....	92
13120220.....	59	13127804.....	59	BSC-12030.....	57
13120222.....	59	13127808.....	59	BSS-12030.....	57
13120224.....	59	13127810.....	59	DIN908-R1-4-5.8.....	84
13120226.....	59	13127812.....	59	DIN912-M6x45-8.8D2R.....	55
13120228.....	59	13127816.....	59	DIN912-M6x45-8.8D2R.....	55
13120230.....	59	13127818.....	59	DIN912-M6x60-8.8D2R.....	55
13120232.....	59	13140901.....	19	DIN912-M6x60-8.8D2R.....	55
13120234.....	59	13140904.....	19	DIN7603-A18x22-CU.....	53
13120236.....	59	13140906.....	19	FLM12-2000+299.....	29
13120238.....	59	13140907.....	19	FLM24-2000+299.....	29
13120240.....	59	13140908.....	19	FLM24-S10+299.....	29
13120300.....	59	13140909.....	19	FLMF12-2000+299.....	29
13120310.....	59	13140911.....	19	FLMF12-BW3-2+299.....	15
13120312.....	59	13140912.....	19	FLMF12-BW7+299.....	15
13120314.....	59	13140913.....	19	FLMF12-BW16+299.....	15
13120320.....	59	13141098.....	17	FLMF24-2000+299.....	29
13120330.....	59	13141099.....	17	FLMF24-BW51-S2+MWZ.....	15
13120331.....	59	13141100.....	17	FLMF24-S10+299.....	29
13120334.....	59	13143400.....	17	GD60.02.....	101
13120342.....	59	13143410.....	17	GD80.02.....	101
13120344.....	59	13143420.....	17	GD100.02.....	101
13120346.....	59	13143430.....	17	M1-2000+299.....	27
13120348.....	59	13143450.....	17	M2-2000+299.....	27

# Index

M2-2004+299.....	27	SKF-OCU-30-P-400-WAC.....	19	ZM805-2-S2+1FV.....	41
M2-2127+299.....	27	SKF-OCU-30-P-400-XX.....	19	ZM1002+1FV.....	41
M2-S14+299.....	27	VD1-102.....	49	ZM1002-3+1FV.....	41
M5-2000+299.....	27	VD1-103.....	49	ZM1002-S2+1FV.....	41
M5-2013+299.....	27	VD1-104.....	49	ZM1005+1FV.....	41
M5-2024+299.....	27	VD1-105.....	49	ZM1005-3+1FV.....	41
M5-S12+299.....	27	VD1-106.....	49	ZM1005-S2+1FV.....	41
M10-2002+299.....	27	VD1-107.....	49	ZM1025+1FV.....	41
MF1-2000+299.....	27	VD1-108.....	49	ZM1025-3+1FV.....	41
MF1-2006+299.....	27	VD1-109.....	49	ZM1035+1FV.....	41
MF1-BW3-S20+1FV.....	13	VD2-102.....	49	ZM2101-1+1FV.....	41
MF1-KW3-S15+1FX.....	13	VD2-103.....	49	ZM2102-1+1FV.....	41
MF2-2000+299.....	27	VD2-104.....	49	ZM2103+1FV.....	41
MF2-2127+299.....	27	VD2-105.....	49	ZM2103-1+1FV.....	41
MF2-BW7+299.....	13	VD2-109.....	49	ZM2104-1+1FV.....	41
MF2-KW6-S8+299.....	13	VD3-099.....	49	ZM2201+1FV.....	41
MF2-S12+299.....	27	VD3-100.....	49	ZM2202+1FV.....	41
MF5-2000+299.....	27	VD3-101.....	49	ZP1.....	31
MF5-2014+299.....	27	VD3-102.....	49	ZP1-S1.....	31
MF5-BW7+140.....	13	VD4-099.....	49	ZP12-2.....	31
MF5-BW16-S223+299.....	13	VD4-100.....	49		
MF5-BW51-S22+29G.....	13	WS63-2.....	98		
MF5-KW6+299.....	13	WS68.....	99		
MF5-S12+299.....	27	WVN200-10.....	35		
MF10-2001+299.....	27	ZM12-21+1FV.....	33		
MF10-S12+299.....	27	ZM12-21-S11+1HM.....	33		
MF210-2001+299.....	27	ZM12-31+1FV.....	33		
SF05A.....	57	ZM25-2+1FV.....	33		
SF10A.....	57	ZM212-21+1FV.....	41		
SF15A.....	57	ZM212-31+1FV.....	41		
SF20A.....	57	ZM402-2-S2+1FV.....	41		
SF30A.....	57	ZM405-2-S2+1FV.....	41		
SKF-OCU-5-P-400-AIC.....	19	ZM502+1FV.....	41		
SKF-OCU-5-P-400-WAC.....	19	ZM502-3+1FV.....	41		
SKF-OCU-5-P-400-XX.....	19	ZM502-S2+1FV.....	41		
SKF-OCU-10-P-400-AIC.....	19	ZM505+1FV.....	41		
SKF-OCU-10-P-400-WAC.....	19	ZM505-3+1FV.....	41		
SKF-OCU-10-P-400-XX.....	19	ZM505-S2+1FV.....	41		
SKF-OCU-30-P-400-AIC.....	19	ZM802-2-S2+1FV.....	41		





#### **Important information on product usage**

SKF and Lincoln lubrication systems or their components are not approved for use with gases, liquefied gases, pressurized gases in solution and fluids with a vapor pressure exceeding normal atmospheric pressure (1 013 mbar) by more than 0,5 bar at their maximum permissible temperature.



[skf.com](https://skf.com) | [skf.com/lubrication](https://skf.com/lubrication) | [lincolnindustrial.com](https://lincolnindustrial.com)

© SKF and Lincoln are registered trademarks of the SKF Group.

© SKF Group 2019

The contents of this publication are the copyright of the publisher and may not be reproduced (even extracts) unless prior written permission is granted. Every care has been taken to ensure the accuracy of the information contained in this publication but no liability can be accepted for any loss or damage whether direct, indirect or consequential arising out of the use of the information contained herein.

**PUB LS/P1 18000 EN** · August 2019

Certain image(s) used under license from Shutterstock.com